



MUSIC SYNTHESIZER

MX49

MX61

MX88

Owner's Manual

For Instrument

SPECIAL MESSAGE SECTION

This product utilizes batteries or an external power supply (adapter). DO NOT connect this product to any power supply or adapter other than one described in the manual, on the name plate, or specifically recommended by Yamaha.

WARNING: Do not place this product in a position where anyone could walk on, trip over, or roll anything over power or connecting cords of any kind. The use of an extension cord is not recommended! If you must use an extension cord, the minimum wire size for a 25' cord (or less) is 18 AWG. NOTE: The smaller the AWG number, the larger the current handling capacity. For longer extension cords, consult a local electrician.

This product should be used only with the components supplied or; a cart, rack, or stand that is recommended by Yamaha. If a cart, etc., is used, please observe all safety markings and instructions that accompany the accessory product.

SPECIFICATIONS SUBJECT TO CHANGE:

The information contained in this manual is believed to be correct at the time of printing. However, Yamaha reserves the right to change or modify any of the specifications without notice or obligation to update existing units.

This product, either alone or in combination with an amplifier and headphones or speaker/s, may be capable of producing sound levels that could cause permanent hearing loss. DO NOT operate for long periods of time at a high volume level or at a level that is uncomfortable. If you experience any hearing loss or ringing in the ears, you should consult an audiologist. **IMPORTANT:** The louder the sound, the shorter the time period before damage occurs.

Some Yamaha products may have benches and / or accessory mounting fixtures that are either supplied with the product or as optional accessories. Some of these items are designed to be dealer assembled or installed. Please make sure that benches are stable and any optional fixtures (where applicable) are well secured **BEFORE** using.

Benches supplied by Yamaha are designed for seating only. No other uses are recommended.

NOTICE:

Service charges incurred due to a lack of knowledge relating to how a function or effect works (when the unit is operating as designed) are not covered by the manufacturer's warranty, and are therefore the owners responsibility. Please study this manual carefully and consult your dealer before requesting service.

ENVIRONMENTAL ISSUES:

Yamaha strives to produce products that are both user safe and environmentally friendly. We sincerely believe that our products and the production methods used to produce them, meet these goals. In keeping with both the letter and the spirit of the law, we want you to be aware of the following:

Battery Notice:

This product MAY contain a small non-rechargeable battery which (if applicable) is soldered in place. The average life span of this type of battery is approximately five years. When replacement becomes necessary, contact a qualified service representative to perform the replacement.

This product may also use "household" type batteries. Some of these may be rechargeable. Make sure that the battery being charged is a rechargeable type and that the charger is intended for the battery being charged.

When installing batteries, never mix old batteries with new ones, and never mix different types of batteries. Batteries **MUST** be installed correctly. Mismatches or incorrect installation may result in overheating and battery case rupture.

Warning:

Do not attempt to disassemble, or incinerate any battery. Keep all batteries away from children. Dispose of used batteries promptly and as regulated by the laws in your area. Note: Check with any retailer of household type batteries in your area for battery disposal information.

Disposal Notice:

Should this product become damaged beyond repair, or for some reason its useful life is considered to be at an end, please observe all local, state, and federal regulations that relate to the disposal of products that contain lead, batteries, plastics, etc. If your dealer is unable to assist you, please contact Yamaha directly.

NAME PLATE LOCATION:

The name plate is located on the bottom of the product. The model number, serial number, power requirements, etc., are located on this plate. You should record the model number, serial number, and the date of purchase in the spaces provided below and retain this manual as a permanent record of your purchase.

Model

Serial No.

Purchase Date

PLEASE KEEP THIS MANUAL

92-BP (bottom)

COMPLIANCE INFORMATION STATEMENT (DECLARATION OF CONFORMITY PROCEDURE)

Responsible Party: Yamaha Corporation of America
Address: 6600 Orangethorpe Ave., Buena Park, Calif. 90620
Telephone: 714-522-9011
Type of Equipment: Music Synthesizer
Model Name: MX49, MX61, MX88

This device complies with Part 15 of the FCC Rules.

Operation is subject to the following two conditions:

- 1) this device may not cause harmful interference, and
- 2) this device must accept any interference received including interference that may cause undesired operation.

See user manual instructions if interference to radio reception is suspected.

* This applies only to products distributed by YAMAHA CORPORATION OF AMERICA. (FCC DoC)

For AC adaptor and Instrument

FCC INFORMATION (U.S.A.)

1. IMPORTANT NOTICE: DO NOT MODIFY THIS UNIT!

This product, when installed as indicated in the instructions contained in this manual, meets FCC requirements. Modifications not expressly approved by Yamaha may void your authority, granted by the FCC, to use the product.

2. IMPORTANT: When connecting this product to accessories and/or another product use only high quality shielded cables. Cable/s supplied with this product **MUST** be used. Follow all installation instructions. Failure to follow instructions could void your FCC authorization to use this product in the USA.

3. NOTE: This product has been tested and found to comply with the requirements listed in FCC Regulations, Part 15 for Class "B" digital devices. Compliance with these requirements provides a reasonable level of assurance that your use of this product in a residential environment will not result in harmful interference with other electronic devices. This equipment generates/uses radio frequencies and, if not installed and used according to the instructions found in the users manual, may cause interference harmful to the opera-

tion of other electronic devices. Compliance with FCC regulations does not guarantee that interference will not occur in all installations. If this product is found to be the source of interference, which can be determined by turning the unit "OFF" and "ON", please try to eliminate the problem by using one of the following measures:

Relocate either this product or the device that is being affected by the interference.

Utilize power outlets that are on different branch (circuit breaker or fuse) circuits or install AC line filter/s.

In the case of radio or TV interference, relocate/reorient the antenna. If the antenna lead-in is 300 ohm ribbon lead, change the lead-in to co-axial type cable.

If these corrective measures do not produce satisfactory results, please contact the local retailer authorized to distribute this type of product. If you can not locate the appropriate retailer, please contact Yamaha Corporation of America, Electronic Service Division, 6600 Orangethorpe Ave, Buena Park, CA90620

The above statements apply **ONLY** to those products distributed by Yamaha Corporation of America or its subsidiaries.

* This applies only to products distributed by YAMAHA CORPORATION OF AMERICA.

(class B)

For AC adaptor

This device complies with Part 15 of the FCC Rules. Operation is subject to the following two conditions: (1) this device may not cause harmful interference, and (2) this device must accept any interference received, including interference that may cause undesired operation.

CAN ICES-3 (B)/NMB-3(B)

- This applies only to products distributed by Yamaha Canada Music Ltd.
- Ceci ne s'applique qu'aux produits distribués par Yamaha Canada Musique Ltée.
(can_b_01)

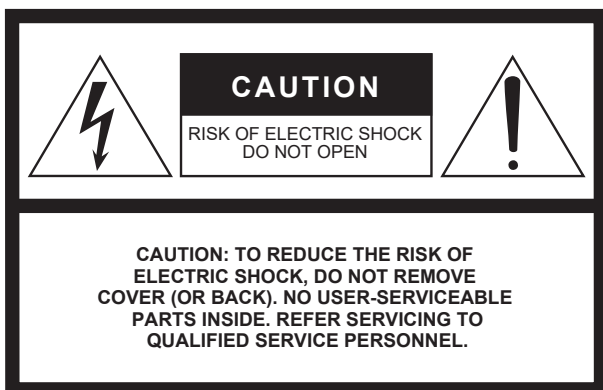

The above warning is located on the rear of the unit.

Explanation of Graphical Symbols

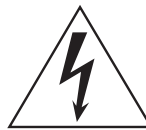

The lightning flash with arrowhead symbol within an equilateral triangle is intended to alert the user to the presence of uninsulated “dangerous voltage” within the product’s enclosure that may be of sufficient magnitude to constitute a risk of electric shock to persons.



The exclamation point within an equilateral triangle is intended to alert the user to the presence of important operating and maintenance (servicing) instructions in the literature accompanying the product.

IMPORTANT SAFETY INSTRUCTIONS

- 1 Read these instructions.
- 2 Keep these instructions.
- 3 Heed all warnings.
- 4 Follow all instructions.
- 5 Do not use this apparatus near water.
- 6 Clean only with dry cloth.
- 7 Do not block any ventilation openings. Install in accordance with the manufacturer’s instructions.
- 8 Do not install near any heat sources such as radiators, heat registers, stoves, or other apparatus (including amplifiers) that produce heat.
- 9 Do not defeat the safety purpose of the polarized or grounding-type plug. A polarized plug has two blades with one wider than the other. A grounding type plug has two blades and a third grounding prong. The wide blade or the third prong are provided for your safety. If the provided plug does not fit into your outlet, consult an electrician for replacement of the obsolete outlet.
- 10 Protect the power cord from being walked on or pinched particularly at plugs, convenience receptacles, and the point where they exit from the apparatus.
- 11 Only use attachments/accessories specified by the manufacturer.
- 12 Use only with the cart, stand, tripod, bracket, or table specified by the manufacturer, or sold with the apparatus. When a cart is used, use caution when moving the cart/apparatus combination to avoid injury from tip-over.
- 13 Unplug this apparatus during lightning storms or when unused for long periods of time.
- 14 Refer all servicing to qualified service personnel. Servicing is required when the apparatus has been damaged in any way, such as power-supply cord or plug is damaged, liquid has been spilled or objects have fallen into the apparatus, the apparatus has been exposed to rain or moisture, does not operate normally, or has been dropped.



WARNING

TO REDUCE THE RISK OF FIRE OR ELECTRIC SHOCK, DO NOT EXPOSE THIS APPARATUS TO RAIN OR MOISTURE.

(UL60065_03)



L'avertissement ci-dessus se trouve à l'arrière de l'instrument.

Explication des symboles graphiques

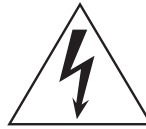

L'éclair avec une flèche à l'intérieur d'un triangle équilatéral est destiné à attirer l'attention de l'utilisateur sur la présence d'une « tension dangereuse » non isolée à l'intérieur de l'appareil, pouvant être suffisamment élevée pour constituer un risque d'électrocution.



Le point d'exclamation à l'intérieur d'un triangle équilatéral est destiné à attirer l'attention de l'utilisateur sur la présence d'instructions importantes sur l'emploi ou la maintenance (réparation) de l'appareil dans la documentation fournie.

CONSIGNES DE SÉCURITÉ À LIRE ATTENTIVEMENT

- 1 Lisez les instructions ci-après.
- 2 Conservez ces instructions.
- 3 Tenez compte des avertissements.
- 4 Suivez toutes les instructions.
- 5 N'utilisez pas cet instrument dans un milieu humide.
- 6 Employez uniquement un chiffon sec pour nettoyer l'instrument.
- 7 N'obstruez pas les ouvertures prévues pour la ventilation. Installez l'instrument conformément aux instructions du fabricant.
- 8 N'installez pas l'instrument près d'une source de chaleur, notamment un radiateur, une bouche de chaleur, un poêle ou autres (y compris les amplificateurs).
- 9 Ne modifiez pas les caractéristiques de la fiche avec mise à la terre polarisée. Une fiche polarisée est dotée de deux broches (l'une est plus large que l'autre). Une fiche avec mise à la terre comprend deux broches, ainsi qu'une troisième qui relie l'instrument à la terre. La broche la plus large (ou troisième broche) permet de sécuriser l'installation électrique. Si vous ne pouvez pas brancher le cordon d'alimentation dans la prise d'alimentation, demandez à un électricien de la remplacer.
- 10 Protégez le cordon d'alimentation. Cela permet d'éviter de marcher dessus ou de le tordre au niveau de la fiche, de la prise d'alimentation et des points de contact sur l'instrument.
- 11 N'employez que les dispositifs/accessoires indiqués par le fabricant.
- 12 Utilisez uniquement le chariot, le socle, le trépied, le support ou le plan indiqués par le fabricant ou livrés avec l'instrument. Si vous utilisez un chariot, soyez prudent si vous le déplacez avec l'instrument posé dessus pour éviter de le renverser.
- 13 Débranchez l'instrument en cas d'orage ou lorsque vous ne l'utilisez pas pendant des périodes prolongées.
- 14 Confiez toutes les réparations à des techniciens qualifiés. Des réparations sont nécessaires lorsque l'instrument est endommagé, notamment dans les cas suivants : cordon d'alimentation ou fiche défectueuse, liquides ou objets projetés sur l'appareil, exposition aux intempéries ou à l'humidité, fonctionnement anormal ou chute.



AVERTISSEMENT

N'UTILISEZ PAS L'INSTRUMENT SOUS LA PLUIE OU DANS UN ENVIRONNEMENT HUMIDE, FAUTE DE QUOI VOUS RISQUEZ DE PROVOQUER UN INCENDIE OU DE VOUS ÉLECTROCUTER.

(UL60065_03)

PRECAUTIONS

PLEASE READ CAREFULLY BEFORE PROCEEDING

Please keep this manual in a safe and handy place for future reference.

For AC adaptor



WARNING

- This AC adaptor is designed for use with only Yamaha electronic instruments. Do not use for any other purpose.
- Indoor use only. Do not use in any wet environments.



CAUTION

- When setting up, make sure that the AC outlet is easily accessible. If some trouble or malfunction occurs, immediately turn off the power switch of the instrument and disconnect the AC adaptor from the outlet. When the AC adaptor is connected to the AC outlet, keep in mind that electricity is flowing at the minimum level, even if the power switch is turned off. When you are not using the instrument for a long time, make sure to unplug the power cord from the wall AC outlet.

For Instrument



WARNING

Always follow the basic precautions listed below to avoid the possibility of serious injury or even death from electrical shock, short-circuiting, damages, fire or other hazards. These precautions include, but are not limited to, the following:

Power supply/AC adaptor

- Do not place the power cord near heat sources such as heaters or radiators. Also, do not excessively bend or otherwise damage the cord, or place heavy objects on it.
- Only use the voltage specified as correct for the instrument. The required voltage is printed on the name plate of the instrument.
- Use the specified adaptor (page 40) only. Using the wrong adaptor can result in damage to the instrument or overheating.
- Check the electric plug periodically and remove any dirt or dust which may have accumulated on it.

Do not open

- This instrument contains no user-serviceable parts. Do not open the instrument or attempt to disassemble or modify the internal components in any way. If it should appear to be malfunctioning, discontinue use immediately and have it inspected by qualified Yamaha service personnel.

Water warning

- Do not expose the instrument to rain, use it near water or in damp or wet conditions, or place on it any containers (such as vases, bottles or glasses) containing liquids which might spill into any openings. If any liquid such as water seeps into the instrument, turn off the power immediately and unplug the power cord from the AC outlet. Then have the instrument inspected by qualified Yamaha service personnel.
- Never insert or remove an electric plug with wet hands.

Fire warning

- Do not put burning items, such as candles, on the unit. A burning item may fall over and cause a fire.

If you notice any abnormality

- When one of the following problems occur, immediately turn off the power switch and disconnect the electric plug from the outlet. Then have the device inspected by Yamaha service personnel.
 - The power cord or plug becomes frayed or damaged.
 - It emits unusual smells or smoke.
 - Some object has been dropped into the instrument.
 - There is a sudden loss of sound during use of the instrument.

CAUTION

Always follow the basic precautions listed below to avoid the possibility of physical injury to you or others, or damage to the instrument or other property. These precautions include, but are not limited to, the following:

Power supply/AC adaptor

- Do not connect the instrument to an electrical outlet using a multiple-connector. Doing so can result in lower sound quality, or possibly cause overheating in the outlet.
- When removing the electric plug from the instrument or an outlet, always hold the plug itself and not the cord. Pulling by the cord can damage it.
- Remove the electric plug from the outlet when the instrument is not to be used for extended periods of time, or during electrical storms.

Location

- Do not place the instrument in an unstable position where it might accidentally fall over.
- Before moving the instrument, remove all connected cables, to prevent damage to the cables or injury to anyone who might trip over them.
- When setting up the product, make sure that the AC outlet you are using is easily accessible. If some trouble or malfunction occurs, immediately turn off the power switch and disconnect the plug from the outlet. Even when the power switch is turned off, electricity is still flowing to the product at the minimum level. When you are not using the product for a long time, make sure to unplug the power cord from the wall AC outlet.

Connections

- Before connecting the instrument to other electronic components, turn off the power for all components. Before turning the power on or off for all components, set all volume levels to minimum.
- Be sure to set the volumes of all components at their minimum levels and gradually raise the volume controls while playing the instrument to set the desired listening level.

Handling caution

- Do not insert a finger or hand in any gaps on the instrument.
- Never insert or drop paper, metallic, or other objects into the gaps on the panel. This could cause physical injury to you or others, damage to the instrument or other property, or operational failure.
- Do not rest your weight on, or place heavy objects on the instrument, and do not use excessive force on the buttons, switches or connectors.
- Do not use the instrument/device or headphones for a long period of time at a high or uncomfortable volume level, since this can cause permanent hearing loss. If you experience any hearing loss or ringing in the ears, consult a physician.

Yamaha cannot be held responsible for damage caused by improper use or modifications to the instrument, or data that is lost or destroyed.

Always turn the power off when the instrument is not in use.

Even when the [] (Standby/On) switch is in standby status (display is off), electricity is still flowing to the instrument at the minimum level.

When you are not using the instrument for a long time, make sure you unplug the power cord from the wall AC outlet

PRÉCAUTIONS D'USAGE

PRIÈRE DE LIRE ATTENTIVEMENT AVANT DE PROCÉDER À TOUTE MANIPULATION

Rangez ce manuel en lieu sûr et à portée de main afin de pouvoir le consulter ultérieurement.

Adaptateur secteur



AVERTISSEMENT

- L'adaptateur secteur est conçu pour être utilisé exclusivement avec les instruments de musique électroniques Yamaha. Ne l'affectez pas à un autre usage.
- Utilisation en intérieur uniquement. N'utilisez pas l'adaptateur dans un environnement humide.



ATTENTION

- Lors de l'installation, assurez-vous que la prise secteur est facilement accessible. En cas de problème ou de dysfonctionnement, désactivez immédiatement l'interrupteur d'alimentation de l'instrument et retirez l'adaptateur secteur de la prise de courant. Lorsque l'adaptateur secteur est branché dans la prise secteur, gardez à l'esprit qu'une faible dose d'électricité circule toujours dans l'instrument, même si l'interrupteur d'alimentation est désactivé. Lorsque vous n'utilisez pas l'instrument pendant une période prolongée, veillez à débrancher le cordon d'alimentation de la prise murale.

Instrument



AVERTISSEMENT

Veillez à toujours observer les précautions élémentaires énumérées ci-après pour éviter de graves blessures, voire la mort, en raison d'une électrocution, d'un court-circuit, de dégâts, d'un incendie ou de tout autre risque. La liste de ces précautions n'est pas exhaustive :

Alimentation/Adaptateur secteur

- Ne laissez pas le cordon d'alimentation à proximité de sources de chaleur telles que les radiateurs ou les éléments chauffants. Évitez également de le plier de façon excessive ou de l'endommager de quelque manière que ce soit ou de placer dessus des objets lourds.
- Utilisez uniquement la tension requise pour l'instrument. Celle-ci est indiquée sur la plaque du fabricant de l'instrument.
- Utilisez uniquement l'adaptateur spécifié (page 40). L'utilisation d'un adaptateur inapproprié peut endommager l'instrument ou entraîner une surchauffe.
- Vérifiez périodiquement l'état de la fiche électrique, dépoussiérez-la et nettoyez-la.

Ne pas ouvrir

- L'instrument ne contient aucune pièce nécessitant l'intervention de l'utilisateur. N'ouvrez pas l'instrument et ne tentez pas d'en démonter les éléments internes ou de les modifier de quelque façon que ce soit. Si l'appareil présente des signes de dysfonctionnement, mettez-le immédiatement hors tension et faites-le contrôler par un technicien Yamaha qualifié.

Prévention contre l'eau

- N'exposez pas l'instrument à la pluie et ne l'utilisez pas près d'une source d'eau ou dans un milieu humide. Ne déposez pas dessus des récipients (tels que des vases, des bouteilles ou des verres) contenant des liquides qui risqueraient de s'infiltrer par les ouvertures. Si un liquide, tel que de l'eau, pénètre à l'intérieur de l'instrument, mettez immédiatement ce dernier hors tension et débranchez le cordon d'alimentation de la prise secteur. Faites ensuite contrôler l'instrument par un technicien Yamaha qualifié.
- N'essayez jamais de retirer ou d'insérer une fiche électrique avec les mains mouillées.

Prévention contre les incendies

- Ne déposez pas des objets présentant une flamme, tels que des bougies, sur l'instrument. Ceux-ci pourraient se renverser et provoquer un incendie.

En cas d'anomalie

- Si l'un des problèmes suivant survient, coupez immédiatement l'alimentation et retirez la fiche électrique de la prise. Faites ensuite contrôler l'appareil par un technicien Yamaha.
 - Le cordon électrique s'effiloche ou est endommagé.
 - L'instrument dégage une odeur inhabituelle ou de la fumée.
 - Un objet est tombé à l'intérieur de l'instrument.
 - Une brusque perte de son est intervenue durant l'utilisation de l'instrument.



ATTENTION

Observez toujours les précautions élémentaires reprises ci-dessous pour éviter tout risque de blessures corporelles, pour vous-même ou votre entourage, ainsi que la détérioration de l'instrument ou de tout autre bien. La liste de ces précautions n'est pas exhaustive :

Alimentation/Adaptateur secteur

- N'utilisez pas de connecteur multiple pour brancher l'instrument sur une prise secteur. Cela risque d'affecter la qualité du son, voire de provoquer la surchauffe de la prise.
- Veillez à toujours saisir la fiche, et non le cordon, pour débrancher l'instrument de la prise d'alimentation. Si vous tirez sur le cordon, vous risquez de l'endommager.
- Débranchez la fiche électrique de la prise secteur lorsque vous n'utilisez pas l'instrument pendant un certain temps ou en cas d'orage.

Emplacement

- Ne placez pas l'instrument dans une position instable afin d'éviter qu'il ne tombe accidentellement.
- Avant de déplacer l'instrument, débranchez-en tous les câbles afin d'éviter de les endommager ou de blesser quiconque risquerait de trébucher dessus.
- Lors de la configuration de l'instrument, assurez-vous que la prise secteur que vous utilisez est facilement accessible. En cas de problème ou de dysfonctionnement, coupez immédiatement l'alimentation et retirez la fiche de la prise. Même lorsque l'interrupteur d'alimentation est en position d'arrêt, du courant électrique de faible intensité continue de circuler dans l'instrument. Si vous n'utilisez pas l'instrument pendant une période prolongée, veillez à débrancher le cordon d'alimentation de la prise murale.

Connexions

- Avant de raccorder l'instrument à d'autres appareils électroniques, mettez ces derniers hors tension. Avant de mettre ces appareils sous ou hors tension, réglez tous les niveaux de volume sur le son minimal.
- Veillez également à régler tous les appareils sur le volume minimal et à augmenter progressivement les commandes de volume tout en jouant de l'instrument pour obtenir le niveau sonore souhaité.

Précautions de manipulation

- Ne glissez pas les doigts ou la main dans les fentes de l'instrument.
- Évitez d'insérer ou de laisser tomber des morceaux de papier, des pièces métalliques ou tout autre objet dans les interstices du panneau. Vous pourriez vous blesser ou provoquer des blessures à votre entourage, endommager l'instrument ou un autre bien ou causer des dysfonctionnements au niveau de l'instrument.
- Ne vous appuyez pas sur l'instrument et ne déposez pas d'objets lourds dessus. Ne manipulez pas trop brutalement les touches, les sélecteurs et les connecteurs.
- N'utilisez pas l'instrument ou le casque de manière prolongée à des niveaux sonores trop élevés ou inconfortables qui risqueraient d'entraîner des troubles définitifs de l'audition. Si vous constatez une baisse d'acuité auditive ou que vous entendez des sifflements, consultez un médecin.

Yamaha ne peut être tenu responsable des détériorations causées par une mauvaise manipulation de l'instrument ou par des modifications apportées par l'utilisateur, ni des données perdues ou détruites.

Mettez toujours l'instrument hors tension lorsque vous ne l'utilisez pas.

Notez que même lorsque l'interrupteur [] (Veille/Marche) est en position de veille (l'écran est éteint), une faible quantité de courant électrique circule toujours dans l'instrument.

Lorsque vous n'utilisez pas l'instrument pendant une période prolongée, veillez à débrancher le cordon d'alimentation de la prise murale.

The model number, serial number, power requirements, etc., may be found on or near the name plate, which is at the bottom of the unit. You should note this serial number in the space provided below and retain this manual as a permanent record of your purchase to aid identification in the event of theft.

Model No.

Serial No.

(bottom_en_01)

OBSERVERA!

Apparaten kopplas inte ur växelströmskällan (nätet) så länge som den är ansluten till vägguttaget, även om själva apparaten har stängts av.

ADVARSEL: Netspændingen til dette apparat er IKKE afbrudt, så længe netledningen sidder i en stikkontakt, som er tændt — også selvom der er slukket på apparatets afbryder.

VAROITUS: Laitteen toisiopiiriin kytketty käyttökytkin ei irroita koko laitetta verkosta.

(standby)

Information for users on collection and disposal of old equipment:



This symbol on the products, packaging, and/or accompanying documents means that used electrical and electronic products should not be mixed with general household waste.

For proper treatment, recovery and recycling of old products, please take them to applicable collection points, in accordance with your national legislation.

By disposing of these products correctly, you will help to save valuable resources and prevent any potential negative effects on human health and the environment which could otherwise arise from inappropriate waste handling.

For more information about collection and recycling of old products, please contact your local municipality, your waste disposal service or the point of sale where you purchased the items.

For business users in the European Union:

If you wish to discard electrical and electronic equipment, please contact your dealer or supplier for further information.

Information on Disposal in other Countries outside the European Union:

This symbol is only valid in the European Union. If you wish to discard these items, please contact your local authorities or dealer and ask for the correct method of disposal.

(weee_eu_en_02)

NOTICE

To avoid the possibility of malfunction/ damage to the product, damage to data, or damage to other property, follow the notices below.

■ Handling and Maintenance

- Do not use the instrument in the vicinity of a TV, radio, stereo equipment, mobile phone, or other electric devices. Otherwise, the instrument, TV, or radio may generate noise. When you use the instrument along with an application on your iPad, iPhone or iPod touch, we recommend that you set "Airplane Mode" to "ON" on that device in order to avoid noise caused by communication.
- Do not expose the instrument to excessive dust or vibrations, or extreme cold or heat (such as in direct sunlight, near a heater, or in a car during the day) to prevent the possibility of panel disfiguration, damage to the internal components or unstable operation.
- Do not place vinyl, plastic or rubber objects on the instrument, since this might discolor the panel or keyboard.
- When cleaning the instrument, use a soft, cloth. Do not use paint thinners, solvents, alcohol, cleaning fluids, or chemical-impregnated wiping cloths.

■ Saving data

- The data in the instrument's Edit Buffer (memory location for edited data) is lost when you turn off the power to the instrument. Save the data to the user memory (internal storage memory), or to USB flash drive/an external device such as a computer. However, the data saved to the user memory may be lost due to some failure, an operation mistake, etc. Save your important data onto USB flash drive/an external device such as a computer.
- To protect against data loss through USB flash drive damage, we recommend that you save your important data onto spare USB flash drive or an external device such as a computer as backup data.

Information

■ About copyrights

- Copying of the commercially available musical data including but not limited to MIDI data and/or audio data is strictly prohibited except for your personal use.
- This product incorporates and bundles contents in which Yamaha owns copyrights or with respect to which Yamaha has license to use others' copyrights. Due to copyright laws and other relevant laws, you are NOT allowed to distribute media in which these contents are saved or recorded and remain virtually the same or very similar to those in the product.
 - * The contents described above include a computer program, Accompaniment Style data, MIDI data, WAVE data, voice recording data, a score, score data, etc.
 - * You are allowed to distribute medium in which your performance or music production using these contents is recorded, and the permission of Yamaha Corporation is not required in such cases.

■ About functions/data bundled with the instrument

- This device is capable of using various types/formats of music data, and automatically optimizes that data to the proper format before use. As a result, this device may not play back the data exactly as the producers or composers of the data originally intended.

■ About this manual

- The illustrations and LCD screens as shown in this manual are for instructional purposes only, and may appear somewhat different from those on your instrument.
- Windows is a registered trademark of Microsoft® Corporation in the United States and other countries.
- Apple, iTunes, Mac, Macintosh, iPhone, iPad and iPod touch are trademarks of Apple Inc., registered in the U.S. and other countries.
- IOS is a trademark or registered trademark of Cisco in the U.S. and other countries and is used under license.
- The company names and product names in this manual are the trademarks or registered trademarks of their respective companies.

Yamaha may from time to time update firmware of the product without notice for improvement in functions and usability. To take full advantage of this instrument, we recommend that you upgrade your instrument to the latest version. The latest firmware can be downloaded from the website below:

<https://download.yamaha.com/>

Introduction

Thank you for purchasing the Yamaha MX49, MX61, or MX88 (hereafter referred to in this Owner's Manual as this instrument) Music Synthesizer. Please read this owner's manual carefully before using the instrument in order to take full advantage of its various features. When you have finished reading the manual keep it in a safe, accessible place, and refer to it when you need to better understand an operation or function.

Accessories

- Owner's Manual (this book)
- CUBASE AI DOWNLOAD INFORMATION
- AC adaptor*

*May not be included in your area. Please check with your Yamaha dealer.

About the Manuals

This instrument has the following documents and instructional materials.

Included Documents



Owner's Manual (this book)

Describes how to set up your instrument and how to perform basic operations. This is the document you should read first when you start playing and using the instrument.

Online Materials (PDF)



Reference Manual

Describes the internal design of your instrument, how to use a connected computer, and all parameters that can be adjusted and set. The manual includes the following contents.

Basic Structure

- Structure of the MX49, MX61, or MX88
- Controller block
- Tone Generator block
- Effect block
- Arpeggio block
- Song/ Pattern playing block
- Internal memory
- MIDI/Audio signal flow

Using a Connected Computer

- Connecting to a computer
- Creating a Song with a computer

Using iOS Applications

Reference

- Performance
- Song/Pattern settings
- File
- Utility
- Remote mode



Synthesizer Parameter Manual

This general, cross-product document explains parameters, effect types, effect parameters, and MIDI messages that are used for all synthesizers. Read the Owner's Manual and Reference Manual first and then use this parameter manual if necessary to learn more about parameters and terms that relate to Yamaha synthesizers in general.



Data List

Provides lists such as the Voice List, Performance List, Arpeggio Type List, Effect Type List, as well as reference materials such as the MIDI Data table and MIDI Implementation Chart.

How to use the PDF manuals

The Reference Manual, the Synthesizer Parameter Manual, and the Data List are provided as data documents in PDF format. The PDF manuals listed above can be obtained from the Yamaha Downloads web page. To do so, go to the web page using the following URL, enter "MX49," "MX61," or "MX88" into the "Model Name" field, and then click "Search."

Yamaha Downloads:

<https://download.yamaha.com/>

These PDF files can be viewed and read on a computer. When using Adobe® Reader® to view a PDF file, you can search for specific words, print a specific page or link to open a desired section in the manual. The term search and link functions are especially convenient methods of navigating through a PDF file, and we recommend that you use them. The latest version of Adobe Reader can be downloaded from the following URL.

<https://www.adobe.com/products/reader/>

Main Features

■ Dynamic, MOTIF-based Sounds

This instrument contains a wide range of dynamic and authentic waveforms derived directly from the world famous Yamaha MOTIF (including the realistic instrument sounds of acoustic piano, electric piano, synthesizer, drums, and many others). These give you exceptionally high-quality sound for playing and recording in various musical genres. Moreover, you can easily play back phrases of each instrument—even complex phrases impossible to play live—by using the Arpeggio function. The instrument also features an extensive effect system—including VCM (Virtual Circuitry Modeling) Effects, REV-X (high grade Reverb) Effects, and Master EQ. In a wide variety of ways, this instrument truly enhances and inspires your music performance and creation.

■ Easy-to-use user interface

This instrument has been designed for easy playability and simple, intuitive operation. For example, the Category buttons let you quickly select a desired Voice from easy-to-understand groups, based on the general instrument type or sound characteristics. The useful and popular Layer function (playing two Voices together) and Split function (playing two separate Voices with your left and right hands) can also be set instantly. What's more, four Knobs are available on the panel—letting you control twelve aspects of the sound, and tweak them in real time as you play.

■ Highly portable, with easy-to-carry design

This instrument can go virtually wherever you go, thanks to its light weight and compact size. The MX49 is designed slim and trim, so that it easily fits on your desk or in front of your computer. The MX61 has a indented handle at the bottom, allowing you to easily carry it with one hand.

■ Jam along with the Rhythm Patterns and Songs

This instrument features a wealth of dynamic Rhythm Patterns in wide variety of musical genres. You can play the keyboard along with Rhythm Pattern playback—a truly inspiring way to perform! The instrument also conveniently lets you play back MIDI and Audio data contained in USB flash memory—letting you easily use Song data created on computer during live performance, without needing a computer! Plus, an [AUX IN] jack allows you to connect a portable music player, so that you can play the keyboard along with your favorite songs.

■ Full music production capabilities—with just this instrument!

Both MIDI and audio data can be transferred to and from a computer via USB—without the need for a separate audio interface or a MIDI interface. You can record and play MIDI data, record digital audio data from this instrument directly, and monitor the DAW sound from the OUTPUT [L/MONO] jack/ [PHONES] jack.

■ Integration with Cubase

This instrument is specially designed to work seamlessly with Cubase, Steinberg's full-featured DAW software—giving you a comprehensive, all-in-one music production system, in which hardware and software are fully integrated.

■ USB audio and MIDI Class-Compliant for easy connection to iOS applications

This instrument can connect to iOS by using USB Audio/MIDI Class Compliant. You can use Stereo Audio In/Out and MIDI In/Out with iPhone and iPad through Apple's Lightning - USB Camera Adapter. Combining the instrument with an iOS audio application, you can get a mobile audio recording solution.

Contents

| | | | |
|--|-----------|--|-----------|
| PRECAUTIONS | S6 | Using the Arpeggio function | 18 |
| Introduction | 2 | Playing back the Arpeggio | 18 |
| Accessories | 2 | Changing the Arpeggio tempo | 19 |
| About the Manuals | 3 | Changing the Arpeggio type | 19 |
| Included Documents | 3 | Keyboard Octave/Transpose settings | 20 |
| Online Materials (PDF) | 3 | Octave | 20 |
| Main Features | 4 | Transpose | 20 |
| Controls and Functions | 6 | Storing the edited settings | 20 |
| Front Panel | 6 | Playing the Performances | 20 |
| Rear Panel | 8 | Playing back Rhythm Patterns | 21 |
| Setting Up | 9 | Playing the keyboard with the Rhythm Pattern | 21 |
| Power supply | 9 | Changing the Rhythm Pattern type and sound | 22 |
| Connecting speakers or headphones | 9 | Changing the tempo for the Rhythm Pattern | 22 |
| Powering up the system | 9 | Playing the keyboard along with Songs | 23 |
| Auto Power Off function | 10 | Songs compatible with this instrument | 23 |
| Adjusting the volume and the brightness of the display | 10 | Playing back MIDI data of the USB flash memory | 23 |
| Playing the Demo Songs | 10 | Playing back audio data of the USB flash memory | 24 |
| Resetting User Memory to the initial factory settings | 11 | Playing back song data of a portable music player | 25 |
| Basic Operation and Displays | 12 | Creating an original Performance | 25 |
| Moving the cursor | 12 | Selecting the Reverb/Chorus type (Common Edit/Part Edit) | 25 |
| Changing (editing) parameter values | 12 | Changing the Insertion Effect of the Voice (Voice Edit) | 27 |
| Selecting an item from a List | 12 | Changing the Controller Set for the Voice (Voice Edit) | 28 |
| Selecting a page | 13 | Storing a Voice (Voice Store) | 29 |
| Note settings | 13 | Storing a Performance (Performance Store) | 29 |
| Naming (inputting characters) | 13 | Changing Voices smoothly while performing | 30 |
| Leaving the current display | 13 | Making Global System Settings (Utility settings) .. | 31 |
| Quick Guide | 14 | Changing the Master Tune setting | 31 |
| Playing the Voices | 14 | Adjusting the brightness of the display (LCD Contrast) | 31 |
| Selecting a Voice for Part 1 | 14 | Saving/loading files on USB flash memory (File settings) | 31 |
| Selecting a Voice for Part 2 | 15 | Formatting the USB flash memory | 31 |
| Combining Voices (Layer) | 15 | Saving settings to USB flash memory | 32 |
| Playing separate Voices with your left and right hands (Split) | 16 | Loading the settings from a USB flash memory | 32 |
| Changing the tonal qualities of the Voice with the controllers | 17 | Connecting an external MIDI instrument | 33 |
| Controllers on the front panel | 17 | Controlling the instrument from an external MIDI keyboard or synthesizer | 33 |
| External Controllers | 18 | Controlling an external MIDI keyboard or synthesizer from the instrument | 34 |
| | | Appendix | 35 |
| | | Shift Function List | 35 |
| | | Display Messages | 35 |
| | | Troubleshooting | 37 |
| | | Specifications | 40 |
| | | Index | 41 |

Controls and Functions

Front Panel

(The illustration is of the MX49; however, the controls and terminals of the MX61 and MX88 are the same.)

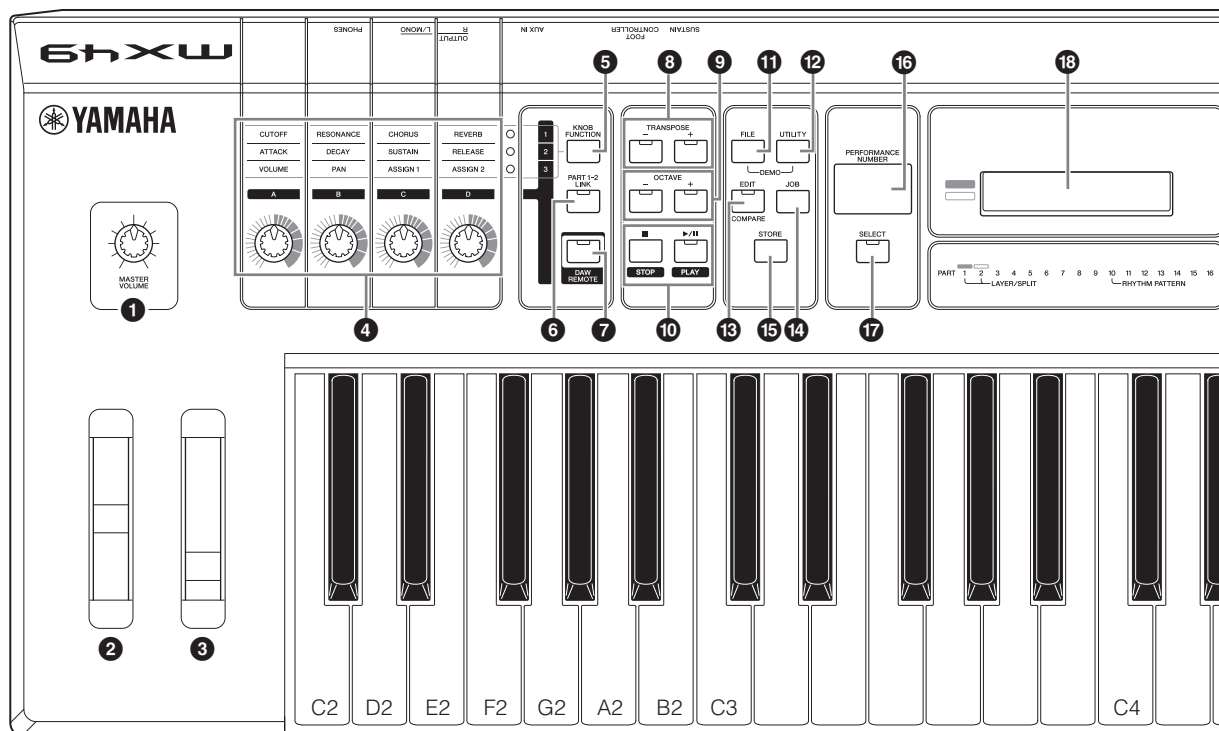

1 [MASTER VOLUME] knob (page 10)

Adjusts the volume of the overall sound.

2 Pitch Bend Wheel (page 17)

Bends the pitch of the notes up or down while playing the keyboard.

3 Modulation Wheel (page 17)

Controls vibrato applied to the sound.

4 Knobs [A] – [D] (page 17)

These four highly versatile knobs let you adjust various aspects or parameters of Parts 1 and 2.

5 [KNOB FUNCTION] button (page 17)

Changes the functions assigned to Knobs [A] – [D].

6 [PART 1-2 LINK] button (page 17)

Determines the sound which is applied to the Knob effects.

7 [DAW REMOTE] button (See Reference Manual)

Turning on this button enters the Remote mode. The Remote mode lets you control DAW software on your computer from the panel controls of the instrument.

8 TRANSPOSE [-]/[+] buttons (page 20)

Use these buttons to raise or lower the pitch of the notes in semitone steps.

9 OCTAVE [-]/[+] buttons (page 20)

Use these buttons to change the note range of the keyboard.

10 Transport buttons (pages 21 and 23)

[■] (Stop) button

Press to stop playback of Rhythm Pattern or Song data.

[▶/||] (Play/Pause) button

Press to alternately start/pause playback of a Rhythm Pattern or Song data from the current point.

11 [FILE] button (page 31)

Calls up the File display from which you can transfer files between this instrument and USB flash memory.

12 [UTILITY] button (page 31)

Calls up the Utility display from which you can set parameters that apply to the entire system of this instrument.

13 [EDIT] button

Calls up the display from which you can edit a Performance (page 20). Also, pressing this button while editing lets you switch between the just-edited sound and its original, unedited condition, allowing you to hear how your edits affect the sound (Compare function).

14 [JOB] button (Refer to the Reference Manual)

Calls up the Performance Job or Utility Job display.

15 [STORE] button

Stores the Performance/Voice/Utility settings.

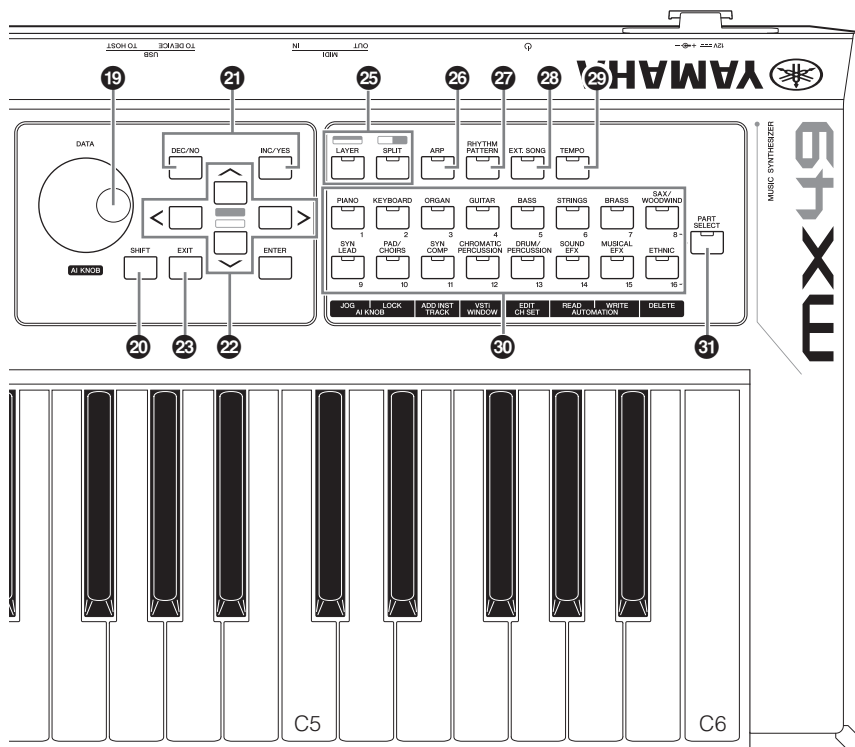

16 [PERFORMANCE NUMBER] display

Indicates the number of the selected Performance.

17 [SELECT] button (page 20)

Calls up the display from which you can select a Performance.

18 LCD (Liquid Crystal Display) (page 10)

The backlit LCD indicates the parameters and values related to the currently selected operation or function.

19 [DATA] dial (page 12)

Changes the selected value in the display.

20 [SHIFT] button (page 35)

Pressing this button along with another button enables you to execute various alternate commands of the respective buttons.

21 [INC/YES]/[DEC/NO] buttons (page 12)

For increasing/decreasing the value of the currently selected parameter.

22 Cursor buttons (page 12)

These move the “cursor” around the display, and scroll through the pages of the edited display.

23 [EXIT] button

The menus and displays of the instrument are organized according to a hierarchical structure. Press this button to exit from the current display and return to the previous level in the hierarchy.

24 [ENTER] button

Use this button to select the display to be edited, to define the value, and to execute a Job or a Store operation.

25 [LAYER] button (page 15), [SPLIT] button (page 16)

These buttons respectively layer different Voices of Parts 1 and 2, and split the keyboard into left and right parts.

26 [ARP] button (page 18)

Determines whether the Arpeggio function is applied to the entire Performance or not.

27 [RHYTHM PATTERN] button (page 21)

Calls up the display from which you can select a Rhythm Pattern.

28 [EXT. SONG] (External Song) button (page 23)

Calls up the display from which you can select Song data of the USB flash memory connected to the USB [TO DEVICE] terminal.

29 [TEMPO] button (pages 19, 22 and 23)

Calls up the display from which you can set the tempo for the Arpeggio/ Rhythm Pattern/ Song.

30 Voice Category button (page 14)

Selects a Voice category for Part 1/Part2.

31 [PART SELECT] button

Calls up the display from which you can select a Part from Parts 1 – 16 and play it.

Rear Panel

MX49, MX61

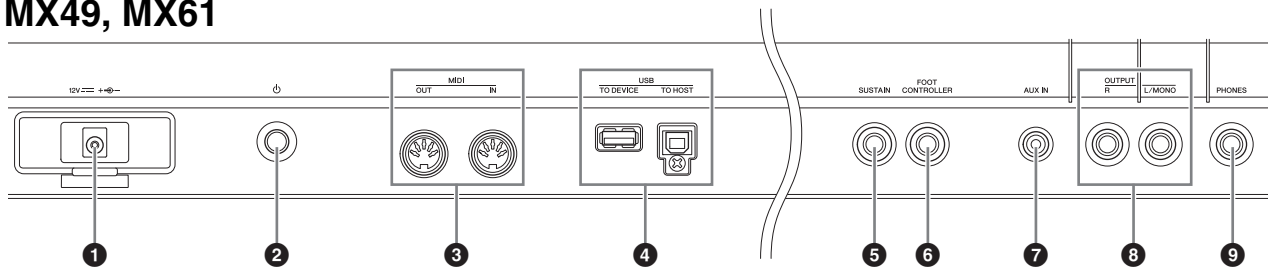

MX88

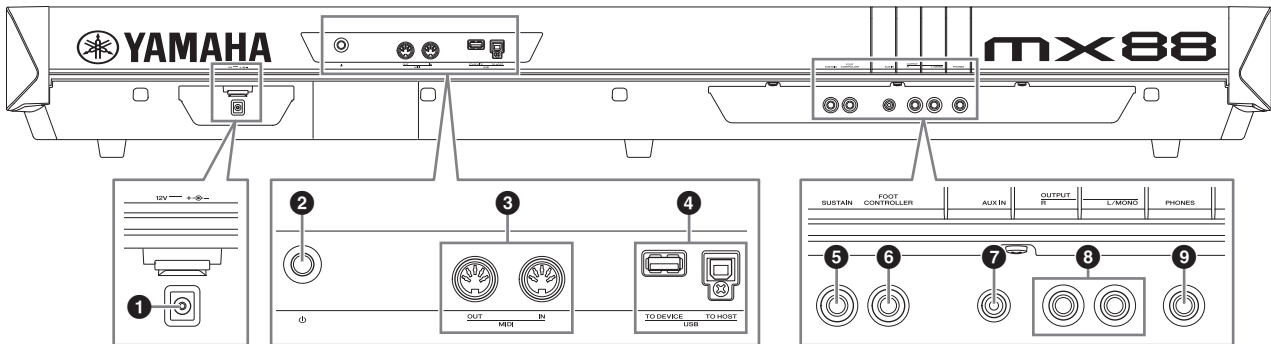

1 DC IN jack (page 9)

Connect the supplied power adaptor to this connector.

2 ⏻ (Standby/On) switch (page 9)

Press to turn the power On (⏻) or set to Standby (⏻).

3 MIDI [IN]/[OUT] terminals (page 33)

MIDI [IN] is for receiving control or performance data from another MIDI device.

MIDI [OUT] is for transmitting all control, performance and playback data from this instrument to another MIDI device.

4 USB terminals

There are two different types of USB terminals, and the rear panel of the instrument features both.

The USB [TO HOST] terminal is used to connect this instrument to the computer via a USB cable and allows you to transfer MIDI data and audio data between the devices. For information about the Port handled by the instrument, refer to the "Reference Manual" PDF document.

The USB [TO DEVICE] terminal is used to connect this instrument to a USB flash memory via a USB cable. For details, see pages 23 and 31.

5 [SUSTAIN] jack (page 18)

For connection of an optional FC3A, FC4A, or FC5 Footswitch. When connecting an FC4A or FC5, this also enables footswitch control over various other functions.

6 [FOOT CONTROLLER] jack (page 18)

For connection of an optional FC7 Foot controller. This jack lets you continuously control one of various different assignable functions—including volume, tone, pitch, or other aspects of the sound.

7 [AUX IN] (Auxiliary Input) jack (page 25)

The Auxiliary Input stereo mini-jack is used to input audio from an external audio device. For example, you can use this jack to connect a portable music player and play along with your favorite music.

NOTE Use the external device's volume control to adjust the desired level balance with this instrument.

8 OUTPUT [L/MONO]/[R] jacks

Line level audio signals are output via these phone jacks. For monophonic output, use only the [L/MONO] jack.

9 [PHONES] (Headphone) jack

This standard stereo phones jack is for connection to a set of stereo headphones. The audio output is identical to that of the OUTPUT [L/MONO]/[R] jack.

Setting Up

Power supply

Make connections for the supplied power adaptor (page 40) in the following order. Before you connect the power adaptor, make sure that the power of this instrument is set to Standby status (■).

- 1 Wrap the DC output cable of the power adaptor around the cable clip (as shown below), then connect the plug of the adaptor to the DC IN jack on the rear panel.

MX49, MX61

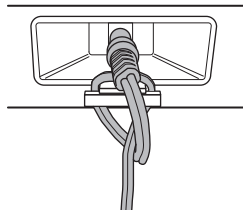

MX88

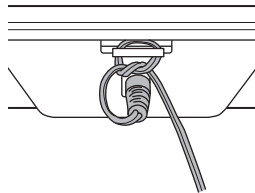

NOTE Use of the cable clip prevents accidental unplugging of the cable during operation. Make sure to avoid tightening the cord more than necessary or pulling on the cord strongly while it is wrapped around the cable clip to prevent wear on the cord or possible breakage of the clip.

- 2 Connect the other end of the power adaptor to an AC outlet.

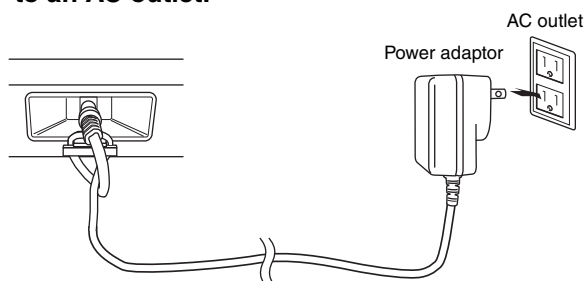

NOTE Follow this procedure in reverse order when disconnecting the power adaptor.

! WARNING

- Use only the specified adaptor (page 40). The use of other adaptors may result in irreparable damage to both the adaptor and the instrument.
- When using the AC adaptor with a removable plug, make sure to keep the plug attached to the AC adaptor. Using the plug alone can cause electric shock or fire.
- Never touch the metallic section when attaching the plug. To avoid electric shock, short circuit or damage, also be careful that there is no dust between the AC adaptor and plug.

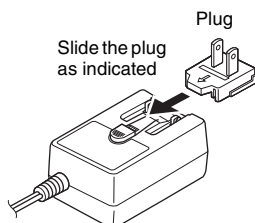

The shape of the plug differs depending on your area.

! CAUTION

Even when the power of this instrument is in the Standby status, electricity is still flowing to the instrument at the minimum level. When you are not using the instrument for a long time, make sure you unplug the power adaptor from the wall AC outlet.

Connecting speakers or headphones

Since this instrument has no built-in speakers, you will need to monitor the sound of the instrument by using external equipment. Connect a set of headphones, powered speakers, or other playback equipment as illustrated below. When making connections, be sure that your cables have the appropriate ratings.

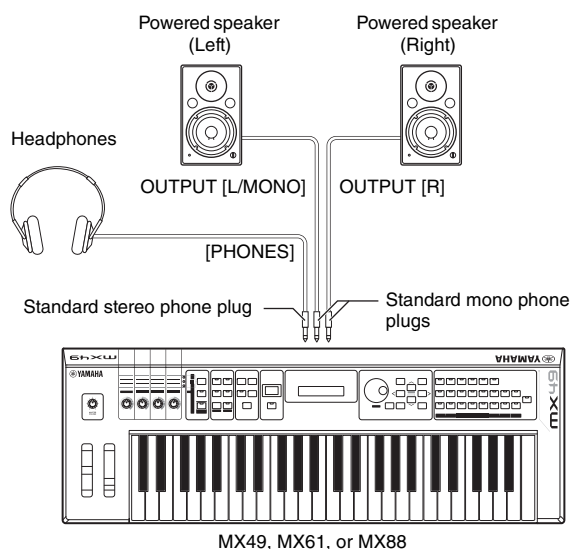

■ NOTICE ■

Before connecting this instrument to external devices, turn off the power to all the devices.

Powering up the system

Make sure the volume settings of this instrument and external devices such as powered speakers are turned down to the minimum before turning the power on. When connecting this instrument to the powered speakers, turn on the power switch of each device in the following order.

When turning the power on:

First, turn the power of the instrument on with the ⏻ (Standby/On) switch, then turn the power of the connected powered speakers on.

When turning the power off:

First, turn the power of the connected powered speakers off, then turn the power of the instrument off with the ⏻ (Standby/On) switch.

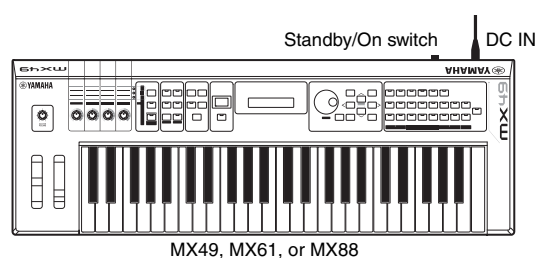

Auto Power Off function

To prevent unnecessary power consumption, this instrument features an Auto Power Off function that automatically turns the power off if the instrument is not operated for a specified period of time. In the default settings, the power will be turned off if this instrument is not operated for 30 minutes.

If you wish to disable the Auto Power Off function, turn the power on while holding down the lowest key on the keyboard. An “Auto power off disabled” message appears briefly and Auto Power Off is disabled. The setting is retained even if the power is turned off.

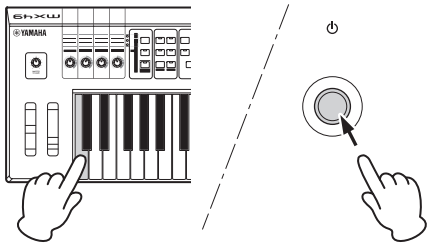

The amount of time that elapses before the power is automatically turned off can be set by the following operation.

[UTILITY] → Select “01:General” with Cursor [^] button
→ [ENTER] → Select “AutoOff” with Cursor [v] button,
then change the value with [DATA] dial → [STORE]

NOTICE

- Depending on the instrument status (for example, the settings have been modified but not yet stored), the power may not turn off automatically, even after the elapse of the specified period of time. Always turn off the power manually when the instrument is not in use.
- When the instrument is not operated for a specified period of time while connected to an external device such as an amplifier, speaker or computer, make sure to follow the instructions in the Owner’s Manual to turn off the power to the instrument and the connected devices, in order to protect the devices from damage. If you do not want the power to turn off automatically when a device is connected, disable Auto Power Off.
- When Auto Power Off is set to “off,” the value will be retained even if the backup data saved on another device is loaded to the instrument. When Auto Power Off is set to something other than “off,” the value will be overwritten with loaded data.
- Keep in mind that the amount of time that elapses before the power automatically turns off is reset to 30 minutes if you execute the Factory Set function (page 11).

- NOTE**
- The setting time is approximate.
 - To turn the power on after Auto Power Off has been executed, press the Standby/On switch once to set it to Standby, and then press it again to set to On.

Adjusting the volume and the brightness of the display

Adjust the volume levels of this instrument and the connected amplifier/speaker system.

NOTE When connecting to a set of powered speakers or PA equipment, set the Master Volume to about 70%, then raise the volume of the powered speakers or PA equipment to the appropriate level.

CAUTION

Do not listen with the headphones at high volume for long periods of time. Doing so may cause hearing loss.

If the display is not easily visible, while holding down [UTILITY], press [INC/YES]/[DEC/NO] to adjust for optimum visibility.

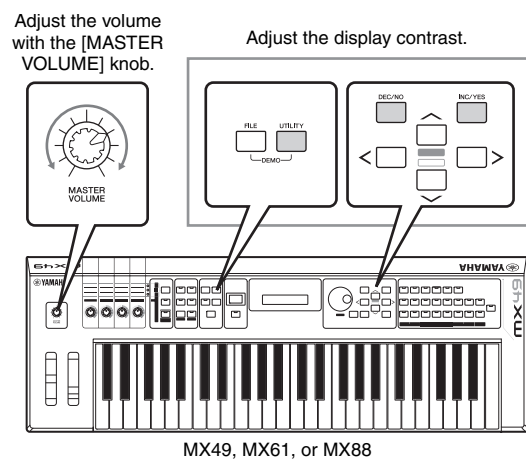

Playing the Demo Songs

The instrument features a variety of Demo Songs, showcasing its dynamic sound and sophisticated functions.

Here’s how to play them back.

- 1 Press [FILE] and [UTILITY] at the same time.
The DEMO display is called up.
- 2 Rotate the [DATA] dial to select a Demo Song.
- 3 Press [▶/||] (Play/Pause) to play back the Demo Song.
The Demo Song currently shown on the display starts.

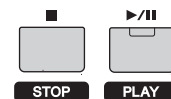

NOTE To adjust the volume level of the Demo Songs, use the [MASTER VOLUME] Knob.

- 4 Press [■] (Stop) to stop the Demo Song.
- 5 In order to leave the DEMO display, press [EXIT].

Resetting User Memory to the initial factory settings

The original factory settings of this synthesizer's User Memory can be restored as described here. The Performances, User Voices, and Utility settings of the User Memory will be reset to the initial factory settings. This operation is especially handy when you've unintentionally deleted or overwritten the Performances or Utility settings.

■ NOTICE ■

When the factory settings are restored, all the Performance, User Voice, and system settings in the Utility display you created will be erased. Make sure you are not overwriting any important data. Be sure to save all important data to your USB flash memory before executing this procedure (page 32).

1 Press [UTILITY], then press [JOB].

The Utility Job Select display is called up.

2 Use the Cursor [^]/[V] buttons to select the "02:FactorySet," then press [ENTER].

The Factory Set display is called up.

```
JOB Factory Set
      PowerOn Auto=off
```

3 Press [ENTER].

The display prompts you for confirmation. To cancel this operation, press [DEC/NO] here. In this case, in order to return to the top display, press [EXIT] repeatedly if necessary after canceling.

```
( Are you sure? )
( [NO]/[YES] )
```

■ NOTICE ■

When setting the "Power On Auto" to on and executing Factory Set, the Factory Set operation will automatically be executed each time you turn the power on. Keep in mind that this also means that your original data in the User Memory will be erased each time you turn on the power. Therefore, the parameter normally is set to off. If you set it to off and execute Factory Set, the Factory Set operation will not be executed when turning the power on the next time.

4 Press [INC/YES].

The Factory Set operation is executed.

■ NOTICE ■

For Factory Set operations that take longer to process, you will see a message during processing. While such a message is shown on the display, do not turn off the power. Turning the power off in this state results in loss of all user data and may cause the system to freeze (due to corruption of data in the User Memory). This could also result in the instrument not being able to start up properly, even when turning the power on next time.

5 Press [EXIT] several times to return to the top display.

Basic Operation and Displays

Moving the cursor

The display cursor indicates a selected item and is shown in the three following types.

■ Arrow type

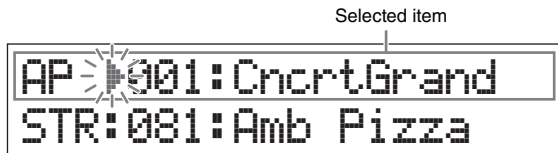

This flashing triangular cursor indicates the selected item's line. You can move the cursor up or down by using the Cursor [^]/[v] buttons.

■ Flash type

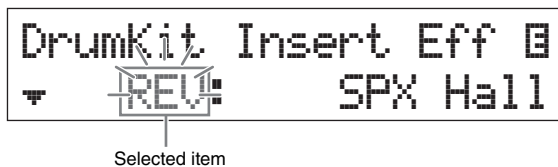

The selected item itself flashes. You can move the cursor indication up/down/left/right by using the Cursor [^]/[v]/[<]/[>] buttons.

■ Underline type

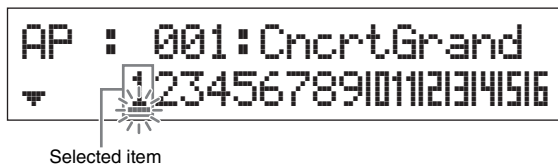

This flashing underline indicates the selected item. This display actually has two cursor indicators: the underline and the flash type. You can move the flash type cursor by using the Cursor [^]/[v] buttons in this display, and move the underline type cursor by using the Cursor [<]/[>] buttons.

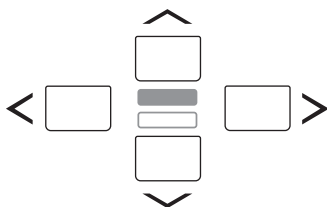

Changing (editing) parameter values

Rotating the [DATA] dial to the right (clockwise) increases the value, while rotating it to the left (counter-clockwise) decreases it. Pressing the [INC/YES] button increases a parameter value by one step, and pressing [DEC/NO] decreases it. Pressing and holding either button continuously increases or decreases the value. For parameters with large value ranges, you can increase the value by 10 by while holding down the [SHIFT] button and pressing the [INC/YES] button. To decrease by 10, simultaneously hold down the [SHIFT] button and press the [DEC/NO] button.

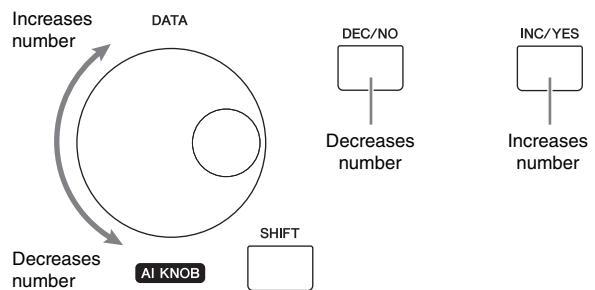

Selecting an item from a list

When there are multiple displays to be edited, the name of each display is indicated in a scrollable list as a selected item.

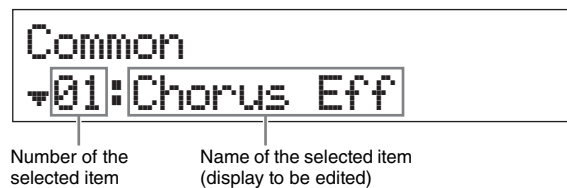

In order to switch the selected item, use the Cursor [^]/[v] buttons, then press [ENTER] to define the selection. The icon displayed to the left of number indicates that other items are available up (▲) or down (▼) in the list.

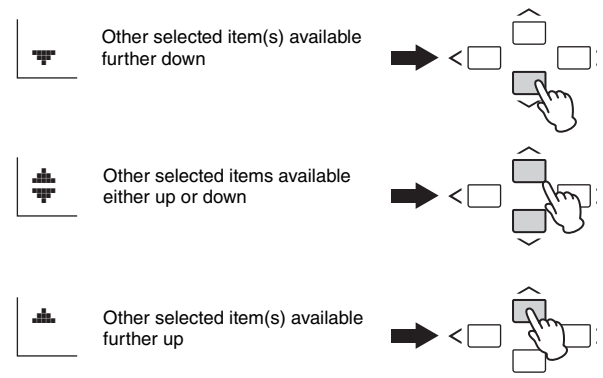

Selecting a page

The display to be edited may consist of multiple pages. In this case, the upper (▲) / lower (▼) icons are indicated at the bottom left of the display. You can select a page by using the Cursor [^]/[V] buttons.



Indicates availability of other pages

Parameter which can be edited

Note settings

Pressing a key lets you set a note value for the Split Point parameter (page 16). You can set the desired Split Point by holding down [SPLIT] and pressing the corresponding key (only when [SPLIT] is set to on; the lamp lights).

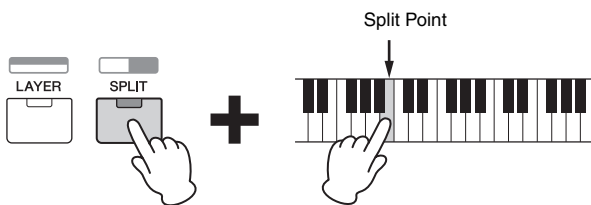

Naming (inputting characters)

You can freely name the data you've created, such as that of Voices and Performances. First, move the cursor to the desired location in the name with the Cursor [<]/[>] buttons, and select the character by using the [DATA] dial or the [INC/YES]/[DEC/NO] buttons.



Selected location flashes

Leaving the current display

If you wish to return to the previous display from the current display, press [EXIT]. In order to return to the top display, press [EXIT] repeatedly.

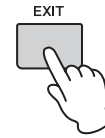

NOTE If you wish to leave the Remote mode (refer to the "Reference Manual" PDF document), you need to press [DAW REMOTE] instead of [EXIT].

Quick Guide

Playing the Voices

The instrument consists of 16 Parts. Voices, which are the basic sounds and building blocks of the instrument, are assigned to each Part. After the instrument is turned on, the top display which appears shows the Voices of only Parts 1 and 2. With the default settings, playing the keyboard will sound only the Voice for Part 1. Select the desired Voice from the various preset Voices and play it.

Top display

Voice for Part 1 AP #001:CncrtGrand
Voice for Part 2 STR:#081:Amb Pizza

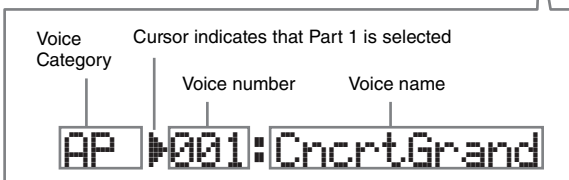

HINT

The instructions of the “Playing the Voices” section assume that you are starting from the top display with the default settings immediately after turning this instrument on. If the instrument is in a different status, or for some reason you cannot return to the top display with the default settings, simultaneously hold down [SHIFT] and press [SELECT]. This is the Quick Reset function and allows you to return operation to the same top display as when the instrument is first turned on.

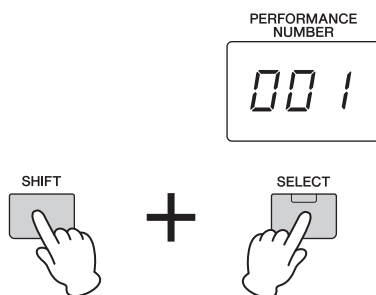

NOTICE

Executing the Quick Reset function above erases any edited data. Be sure to store important data to internal memory (page 29).

NOTE For details about this function, see the “Shift Function List” (page 35).

Selecting a Voice for Part 1

The Voices of the instrument are conveniently divided into specific categories, each based on a general instrument type or sound characteristic. In order to select a Voice, first select a category.

Here, you'll learn how to change Voices and play a Voice while Part 1 is selected.

NOTE For lists of the Voices and categories, see the “DATA LIST” PDF document.

1 Press the desired Voice Category button.

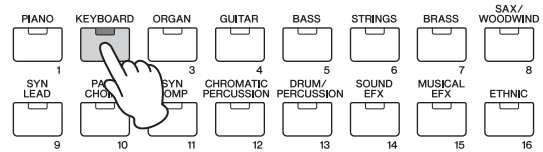

Category of Part 1 is changed.

KB #001:Vintage'74
STR:#081:Amb Pizza

2 Rotate the [DATA] dial to select the desired Voice in the selected category.

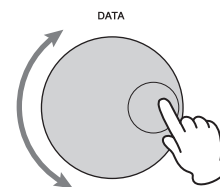

Voice for Part 1 is changed.

KB #004:Soft Case
STR:#081:Amb Pizza

3 Play the keyboard.

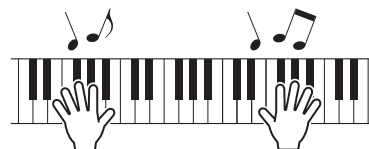

4 Repeat steps 1 – 3 to play the various Voices.

Selecting a Voice for Part 2

Here, you'll learn how to select a Voice for Part 2 as well as Part 1. By setting the Voices of Part 1 and Part 2 in the top display, you can alternate between the two Voices as you play without the sound unnaturally cutting off.

1 Press the Cursor [V] button to select Part 2.

Only Part 2 can now be sounded.

```
KB :004:Soft Case
STR#081:Amb Pizza
```

2 Press the desired Voice Category button.

3 Rotate the [DATA] dial to select a specific desired Voice in the selected category.

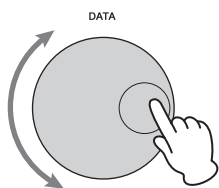

```
KB :004:Soft Case
ORG#001:16+8+5&1/3
```

Voice for Part 2 is changed.

4 Play the keyboard.

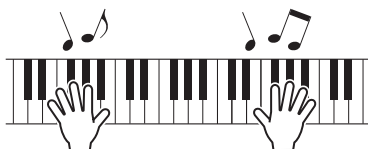

5 While playing the keyboard, press the Cursor [^] button to select Part 1.

The Part 2 sound is maintained for the last key played, and the Voice changes to that of Part 1, which plays from the next key and after.

HINT

Stopping Arpeggio playback

Depending on the selected Voice, you can trigger Arpeggio playback by playing the keyboard. To stop Arpeggio playback at any time, press [ARP]. To enable the Arpeggio function again, press [ARP] so that the lamp lights.

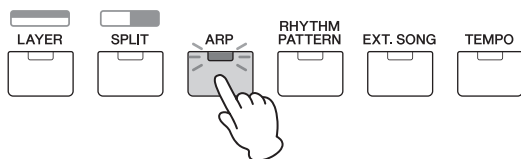

Combining Voices (Layer)

You can select separate Voices for Parts 1 and 2, and play both Voices together in a layer.

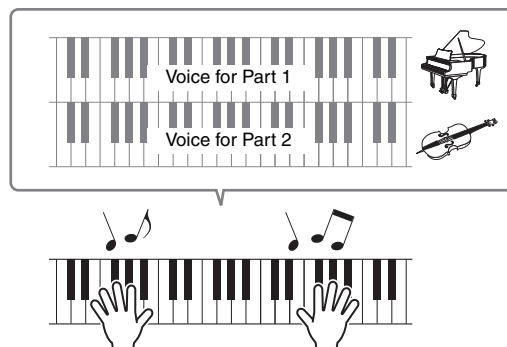

1 Press [LAYER].

Part 1 and Part 2 can now be sounded at the same time (Layer). In the display, Part 2 is selected.

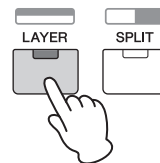

2 Use the Category buttons and the [DATA] dial to select a Voice for Part 2, and check the sound by playing the keyboard.

```
KB :004:Soft Case
ORG#002:Jz2Perc+C3
```

Voice for Part 2 is changed.

NOTE To change the Voice for Part 1, press the Cursor [^] button to select Part 1, then use the Category buttons and the [DATA] dial to select a different Voice.

3 Adjust the volume for Part 1 and Part 2 as desired, checking the sound as you play the keyboard.

Make sure that the lamp of [PART 1-2 LINK] is off, then press the [KNOB FUNCTION] repeatedly to turn on the third lamp. Then adjust the volume for the selected Part with Knob [A]. After returning to the top display, select the other Part with the Cursor [^]/[V] buttons, then adjust the volume with Knob [A] again.

NOTE If the Knob [A] value has brackets, rotating Knob [A] will not change the value until displayed value is reached.

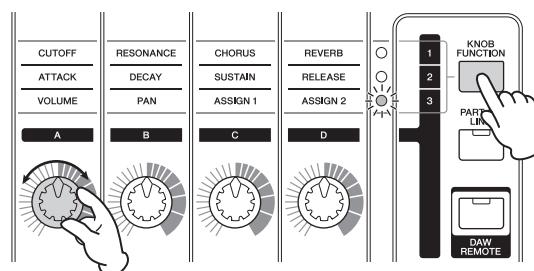

4 To cancel the Layer function, press [LAYER] again.

The [LAYER] lamp turns off, and only the Part 1 Voice sounds.

HINT

Creating a thick, textured sound by layering Voices

By slightly increasing/decreasing the value of the “Detune” parameter for one Part after assigning synthesizer Voices to Parts 1 and 2, you can create a powerful lead synthesizer sound. Experiment with other Voices and the Detune parameter (called up as described below) to create other warm, organic sounds.

[EDIT] → Select “02:Part” → [ENTER] → Select “01:Play Mode” → [ENTER] → Cursor [^]/[v] buttons

Playing separate Voices with your left and right hands (Split)

This function lets you play different Voices with your left and right hands. To use this, assign the Voice for Part 1 to the right part of the keyboard, and Voice for Part 2 to the left. The point (or key) at which the keyboard is split between left and right parts is called the “Split Point.” You can freely set the Split Point to any desired key.

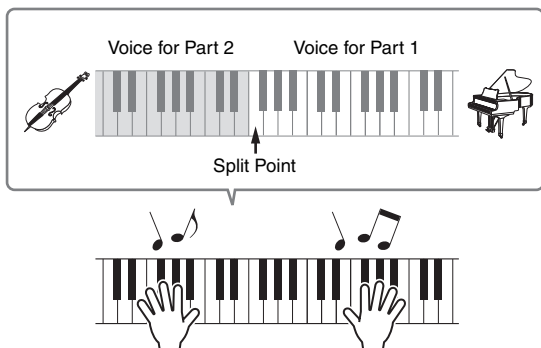

1 Press [SPLIT].

The Voices of Part 1 and Part 2 are split to the left and right of the keyboard, and Part 2 is selected.

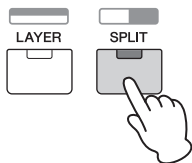

2 Select a Voice for Part 2, using the Category buttons and the [DATA] dial, and check the sound while playing the keyboard.

NOTE To change the Voice for Part 1, press the Cursor [^] button to select Part 1, then use the Category buttons and the [DATA] dial to select a different Voice.

3 To change the Split Point, simultaneously hold down [SPLIT] and press the desired key.

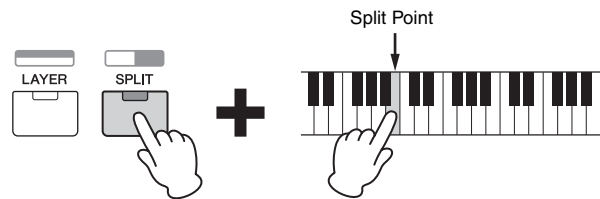

4 Adjust the volume for Part 1 and Part 2 as desired, checking the sound as you play the keyboard.

Make sure that the lamp of [PART 1-2 LINK] is off, then press the [KNOB FUNCTION] repeatedly to turn on the third lamp. Then rotate Knob [A]. The volume for the selected Part is changed. After returning to the top display, select the other Part by using the Cursor [^]/[v] buttons, then adjust the volume by rotating Knob [A] again.

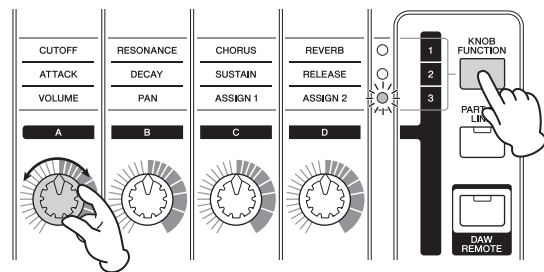

5 To cancel the Split function, press [SPLIT] again.

The [SPLIT] lamp turns off, and only the Part 1 Voice sounds.

HINT

Changing the octave range for a Part

It may be musically useful to change the pitch of the Split Part—for example, setting it to a higher or lower octave. To do this, set the “NoteShift” parameter for the Part to +12 or -12. You can change the pitch of the Part in semitone steps. You can call up NoteShift as follows.

[EDIT] → Select “02:Part” → [ENTER] → Select “01:Play Mode” → [ENTER] → Cursor [^]/[v] button

Changing the tonal qualities of the Voice with the controllers

The instrument features various controllers which let you change the sound of the instrument in real time. These include the Knobs, Pitch Bend Wheel, and Modulation Wheel. You can also control various functions by using external controllers connected to the corresponding jacks on the rear panel.

Controllers on the front panel

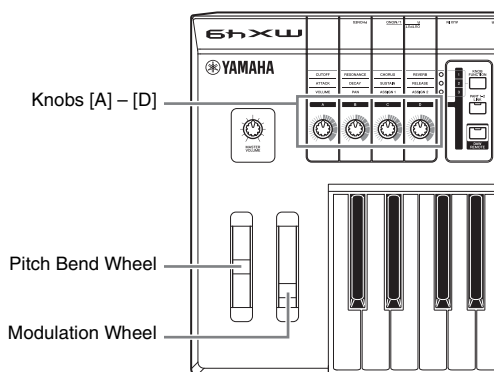

Pitch Bend wheel

Use the Pitch Bend wheel to bend notes up or down while playing the keyboard. This wheel is self-centering and automatically returns to normal pitch when released. Try out the Pitch Bend wheel while pressing a note on the keyboard.

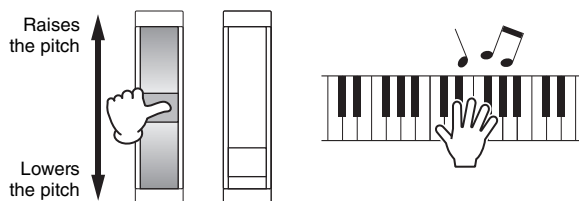

NOTE You can change the maximum pitch bend range by calling up the "PB Upper"/ "PB Lower" parameters as follows and change the values of these parameters.
 [EDIT] → Select "02:Part" → [ENTER] → Select "01:Play Mode" → [ENTER] → Cursor [▲]/[▼] buttons

Modulation wheel

This controller is used to apply vibrato to the keyboard sound. Try out the Modulation wheel with various Preset Voices while playing the keyboard.

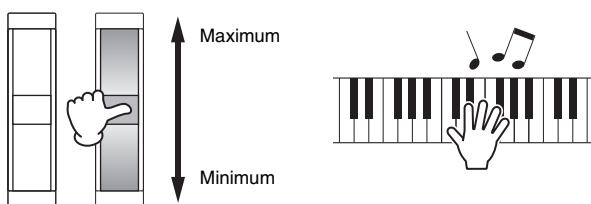

Knobs [A] – [D]

You can change the brightness and tone characteristics of Part 1/Part 2 in realtime by turning the Knobs while you play. Three functions are assigned to each Knob, alternatively selected via the [KNOB FUNCTION] button.

1 Press [KNOB FUNCTION] repeatedly if necessary, so that the lamp corresponding to the desired functions lights.

The Knob Function display which shows the current functions and current values for Knobs [A] – [D] is called up. The values in brackets indicate that the Knob indication is different from the current actual value.

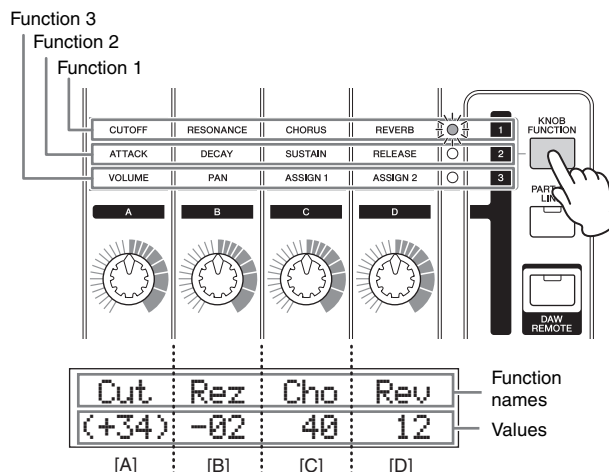

NOTE You can instantly reset Knobs [A] – [D] to Function 1 by holding down [SHIFT] and pressing [KNOB FUNCTION].

2 Press [PART 1-2 LINK] to determine whether the Knob functions are applied to both Part 1 and Part 2 (on), or only the selected Part (off).

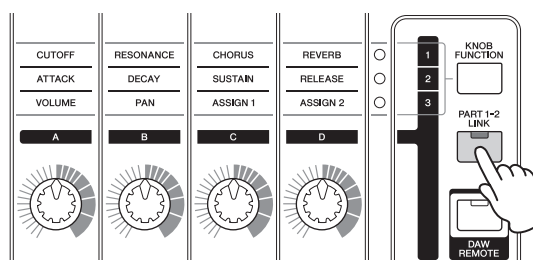

3 While playing the keyboard, rotate one of the Knobs.

The function assigned to the Knob you're currently operating and the function value appear in the Knob Function display. If the value is shown in brackets, rotating the corresponding Knob has no effect on the value until the Knob indication reaches the current value.

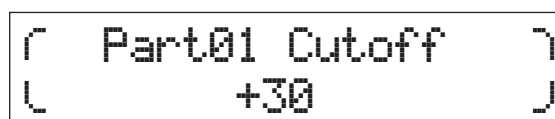

NOTE For details about each function, see the "Reference Manual" PDF document.

External Controllers

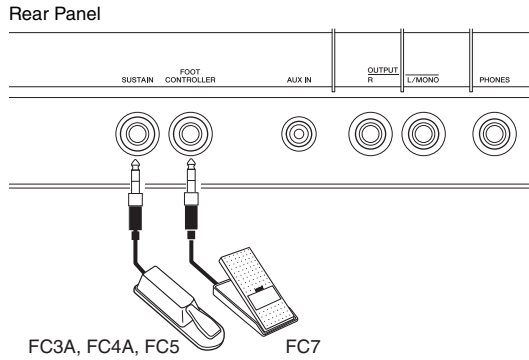

Footswitch

An optional Footswitch (FC3A, FC4A or FC5) connected to the [SUSTAIN] jack on the rear panel lets you control sustain. Notes played while the Footswitch is pressed are sustained longer than normal after you release the corresponding keys, like a damper pedal on an acoustic piano (Sustain function). If you connect an FC3A, you can use the half-damper function for some Voices of the PIANO and KEYBOARD categories. When using the half-damper function, the degree to which the pedal is pressed can control how long the notes are sustained. Change the setting as follows according to the connected Footswitch.

[UTILITY] → Select "03:Controller" → [ENTER] → Select "FS Pedal" parameter → Set "FS Pedal" to connected Footswitch → Return to top display by pressing [EXIT] twice

NOTE If you wish to use the half-damper function, set the "FS Pedal" to "FC3 Half On."

Foot controller

You can connect an optional Foot Controller (FC7) to the [FOOT CONTROLLER] jack on the rear panel. This conveniently lets you use your foot to control volume (like the volume pedal of an organ), freeing your hands for playing.

NOTE You can also control other functions than sustain or volume by using a foot pedal connected to the [SUSTAIN] jack or [FOOT CONTROLLER] jack. For details, see the explanation of the Utility Controller display in the "Reference Manual" PDF document.

HINT

When Sustain is applied to specific Parts

If you wish to apply the sustain effect only to Part 1, set the receive switch of the "Sustain" for Part 2 to off as follows.

[EDIT] → Select "02:Part" → [ENTER] → [KEYBOARD] (2) → Select "04:Receive Switch" → [ENTER] → "Sustain" = "off"

Using the Arpeggio function

The Arpeggio function lets you create arpeggios (broken chords) by simply playing the appropriate notes on the keyboard. For example, you could play the notes of a triad—the root, third, and fifth—and the Arpeggio function will automatically create a variety of interesting arpeggio-type phrases. You can set different Arpeggio types for each Part, and apply the Arpeggio function up to two Parts simultaneously. The most suitable Arpeggio type is automatically selected for each part when you select a voice, but you can easily select any other Arpeggio type.

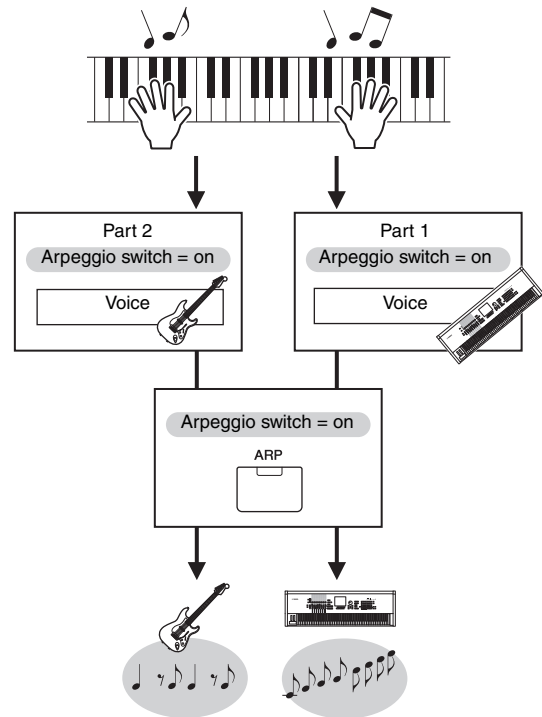

Playing back the Arpeggio

1 Press [EDIT].

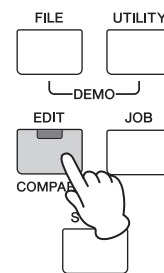

2 Select "02:Part" by pressing the Cursor [V] button, then press [ENTER].

EDIT
*02:Part



3 Select “03:Arp Select” with the Cursor [\wedge]/ [\vee] buttons, then press [ENTER].

This calls up the Edit display related to the Arpeggio for the Part.

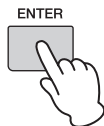

4 Press [PIANO] (1).

This calls up the Edit display for Part 1. (Other Parts can be selected by pressing the appropriate number button 1 – 16.)

5 Select the “Switch” parameter with the Cursor [\wedge] button, then set it to “on” with the [DATA] dial.

The Arpeggio for Part 1 is enabled.

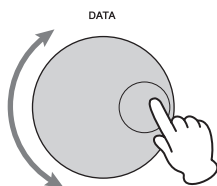
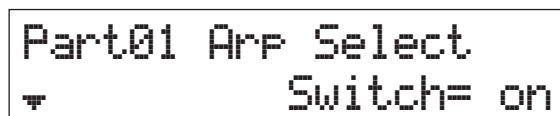

6 If necessary, press [ARP] on the panel so that the lamp lights.

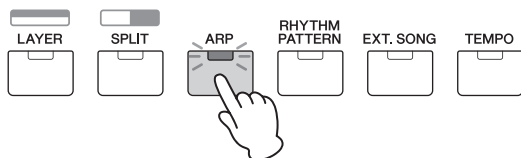

7 Play the keyboard to sound the Arpeggio.

The sound of the Arpeggio produced changes according to the number of notes you play and the area of the keyboard you play in.



8 If Arpeggio playback does not stop after you quit playing, press [ARP] to stop it.

9 If desired, play back the Arpeggio for Part 2 as well as Part 1.

Press [KEYBOARD] (2) (similar to step 4 above), then execute from steps 5 to 8 again.

Changing the Arpeggio tempo

1 Press [TEMPO].

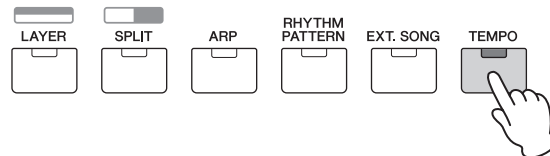

2 While playing back the Arpeggio from the keyboard, change the tempo with the [DATA] dial.



3 Press [EXIT] to leave the Tempo display.

Tap Tempo function

The tempo can also be set by “playing” or tapping the [TEMPO] button several times repeatedly at the desired tempo.

Changing the Arpeggio type

1 Make desired settings according to the instructions of steps 1 – 4 in “Playing back the Arpeggio.”

2 Select the Arpeggio type parameter in page 3 of the Arp Select display with the Cursor [\wedge]/ [\vee] buttons, then change the Arpeggio type while playing the keyboard.

Move the flashing cursor to the Arpeggio category or Arpeggio number with the Cursor [\lt]/ [\gt] buttons, then change the setting with the [DATA] dial.

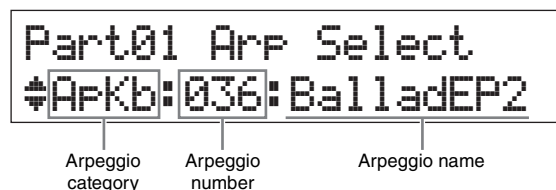

3 If desired, select the “Hold” parameter with the Cursor [\wedge] button, then change the setting with the [DATA] dial.

This parameter determines whether the Arpeggio continues cycling after the keys are released. For details about this parameter, see the “Synthesizer Parameter Manual” PDF document.



Keyboard Octave/ Transpose settings

Octave

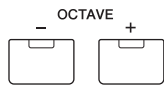

The OCTAVE [-]/[+] button lets you shift the pitch of the keyboard in octaves, up to a maximum of three. For example, you may want to shift the pitch down lower to get extra bass notes, or shift up to get higher notes for leads and solos. Pressing the [-] and the [+] buttons together at the same time will return the setting to the initial value (0).

The current octave range can be confirmed via the status of the lamp of the OCTAVE [-]/[+] buttons. When set to one octave down or up, the corresponding lamp lights. When set to two octaves down or up, the corresponding lamp flashes slowly. When set to three octaves down or up, the corresponding lamp flashes quickly.

Transpose

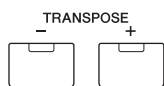

The TRANSPOSE [-]/[+] button lets you shift the pitch of the keyboard in semitones (up to 11 semitones). This function allows you to play in the same position and with the same fingering, even if the Song data or another instrument player is playing in a different key. Pressing the [-] and the [+] buttons together at the same time will return the setting to the initial value (0). When set to one semitone down or up, the corresponding lamp lights.

Storing the edited settings

When you are satisfied with the results, store the settings you've made to internal memory (as a Performance) so that they can be recalled after turning off the power. Press [STORE], then press [ENTER]. Finally, press [INC/YES] to store the settings to Performance 1.

NOTE For detailed instructions on the Store operation, see "Storing the Performance" (page 29).

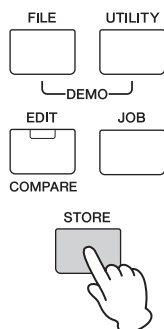

Playing the Performances

A program in which multiple Voices (parts) are combined is referred to as a "Performance," and the instrument has a total of 128 Performances. A Performance consists of up to 16 Parts. The Parts which you normally use for playing the keyboard are Parts 1 and 2.

When turning on this instrument with the factory settings, Performance 1 is called up. In the instructions covered so far (pages 14 – 20), you've played and edited Parts 1 and 2 of Performance 1, which is simply designed for playing one or two Voices. Performances 2 – 128 are provided for enjoying a powerful and thick sound which consists of multiple various Voices. In the instructions below, we'll change the Performance to one of Performances 2 – 128 and play it.

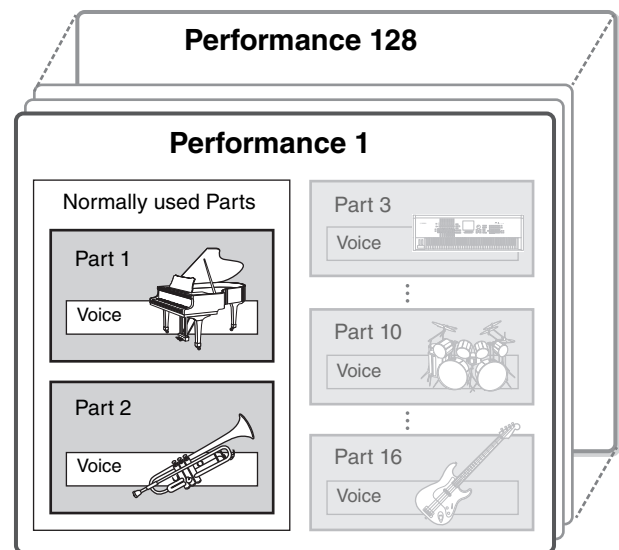

1 Press [SELECT].

The Performance Select display is called up.

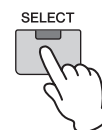

2 Rotate the [DATA] dial to select a Performance.

The selected Performance number is shown in the [PERFORMANCE NUMBER] display.

Performance Select display

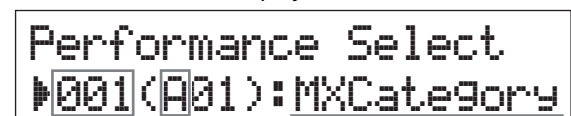

Performance number Performance group Performance name

NOTE For a detailed list of all Performances, see the "Performance List" of the "Data List" PDF document.

NOTE The 128 Performances are divided into eight groups (A – H), each of which consist of sixteen Performances. To select these groups of Performances, simultaneously hold down [SHIFT] and use the [DATA] dial or [INC/YES]/[DEC/NO] buttons.

3 Play the keyboard.

If the lamp of the [▶/||] (Play/Pause) button flashes before playing the keyboard, playing the keyboard starts the Rhythm Pattern (Key On Start function). In this case, play the keyboard with the Rhythm Pattern. To stop the Rhythm Pattern, press [■] (Stop).

Also, if the Arpeggio playback continues after you've finished playing, press [ARP] to stop the Arpeggio.

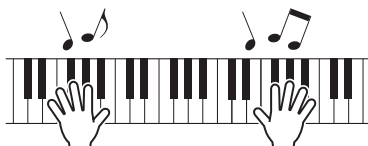

4 When you're done trying out the various Performances, press [EXIT] to return to the Top display.

The display showing the currently selected Part 1 and Part 2 is called up.



PAD:003:AmbSyn Pad
CMP:065:TranceLine

HINT

You can switch the Performance number directly by pressing the [SHIFT] button and the Voice Category button simultaneously in the Performance Select display (Performance Direct Select function). While this function is enabled, you can change the performance number simply by pressing the Voice Category button, without needing to press the [SHIFT] button.

HINT

You can select Performances in sequence with a footswitch by connecting an FC4A/FC5 to the [SUSTAIN] jack and setting as follows. Keep in mind that the sustain function cannot be used in this case. [UTILITY] → Select "03:Controller" → [ENTER] → "FS" = "PC inc" / "PC dec."

Playing back Rhythm Patterns

The instrument features a wide variety of Rhythm Patterns. An appropriate Rhythm Pattern is assigned to each Performance.

Playing the keyboard with the Rhythm Pattern

1 After selecting a Performance, with the [▶/||] (Play/Pause) lamp flashing, play the Keyboard.

If the [▶/||] (Play/Pause) lamp is turned off, press [▶/||] (Play/Pause), then play the keyboard.

The lamp of [▶/||] (Play/Pause) flashes quickly and the Rhythm Pattern plays back.

2 To pause the Rhythm Pattern, press [▶/||] (Play/Pause). To resume playback, press [▶/||] (Play/Pause) again.

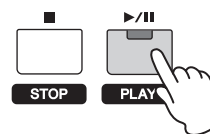

3 Press [■] (Stop) to stop the Rhythm Pattern.

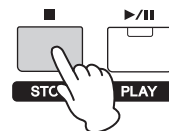

HINT

Using the Key On Start function

The Key On Start function automatically starts a Rhythm Pattern when you play a key on the keyboard. Especially convenient in live performance situations, this allows you to start playing the keyboard and have the Rhythm Pattern instantly start playback at the same time. There are some Performances which are automatically set to standby condition for the Key On Start function. In this case, you can automatically use the Key On Start function simply by playing the keyboard. For other Performances, enable the function as described below.

1 While holding down [■] (Stop) press [▶/||] (Play/Pause).

The lamp of [▶/||] (Play/Pause) flashes slowly, and the selected Performance is set to standby status for the Key On Start function.

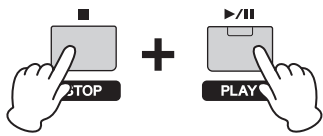

NOTE If you wish to cancel this standby status, press [■] (Stop).

2 Play the keyboard.

The Rhythm Pattern starts at the same time.

3 Press [■] (Stop) to stop the Rhythm Pattern.

NOTE For details about resetting the Key On Start function, see the "Reference Manual" PDF document.

Changing the Rhythm Pattern type and sound

You can select a different Rhythm Pattern to be assigned to the Performance, and even change the Drum Voice used for the Pattern.

1 Press [RHYTHM PATTERN].

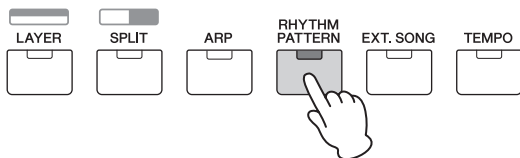

2 Press the Cursor [^] button repeatedly if necessary to call up the 1st page (similar to the one shown below), then press [▶/||] (Play/Pause) and change the Rhythm Pattern type.

Move the cursor to the category or number of the Rhythm Pattern with the Cursor [<]/[>] buttons.

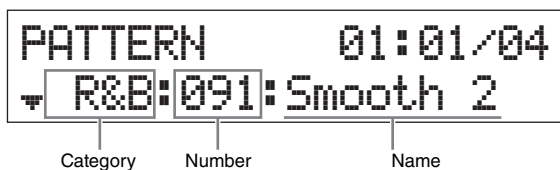

3 Press the Cursor [v] button to call up the 2nd page, then rotate the [DATA] dial to change the Drum Voice.



NOTE You can set additional parameters related to the Rhythm Pattern in other pages. For details about these parameters, see the "Reference Manual" PDF document.

4 When you have finished making the desired Rhythm Pattern settings, press [■] (Stop) to stop the Rhythm Pattern.

Changing the tempo for the Rhythm Pattern

1 Press [TEMPO].

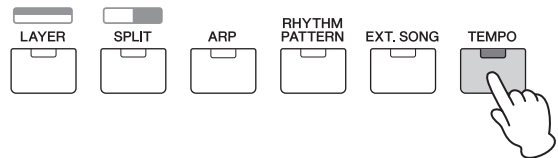

2 Press [▶/||] (Play/Pause) to play back the Rhythm Pattern, then rotate the [DATA] dial to change the tempo.



NOTE This tempo setting is automatically reflected to the Arpeggio tempo and can be set for each Performance.

Tap Tempo function

The tempo can also set by "playing" or tapping the [TEMPO] button several times repeatedly at the desired tempo.

Storing the Rhythm Pattern

You can store the changed Rhythm Pattern settings as Performance data. For instructions on storing a Performance, see page 29.

Playing the keyboard along with Songs

MIDI data and audio data contained in the USB flash memory can be played back as a “Song” on the instrument.

MIDI and audio data

MIDI data is comprised of your keyboard performance information and is not a recording of the actual sound itself. The performance information refers to which keys are played, at what timing, and at what strength—just as in a musical score. Based on the recorded performance information, the tone generator outputs the corresponding sound. Audio data, on the other hand, is a recording of the performed sound itself. This data is recorded in the same way as that used in recording with voice recorders, etc. This data can be played with a portable music player, etc., allowing you to easily let other people hear your performance.

Songs compatible with this instrument

Data formats of MIDI data and audio data that can be played on this instrument are as follows.

MIDI data

Only SMF (Standard MIDI File) MIDI data of format 0 can be used for playback on this instrument. The file extension is “.MID.” This instrument is equipped with a 16-track sequencer for playback and a 16-part multi-timbral tone generator, allowing you to play back MIDI data of up to 16 tracks.

Audio data

Only 44.1kHz/16-bit stereo Wave file audio data can be used for playback on this instrument. The file extension is “.WAV.”

Playing back MIDI data of the USB flash memory

1 Connect the USB flash memory in which the MIDI data is stored.

NOTE Make sure that the desired MIDI data is stored in the root directory (which is called up when you first open the memory location) of the USB flash memory.

2 Press [SELECT], then select an appropriate Performance for playing back the MIDI data.

Performance Select
▶001 (A01):MXCategory

3 Press [EXT. SONG].

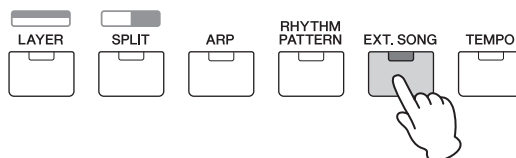

4 Press the Cursor [^] button repeatedly if necessary to call up the 1st page, then rotate the [DATA] dial to select the desired MIDI data.

Current measure and beat for the MIDI data



Name of the MIDI data

5 Press [▶/||] (Play/Pause).

The lamp of [▶/||] (Play/Pause) flashes and the selected MIDI data is played back with the selected Performance sounds.

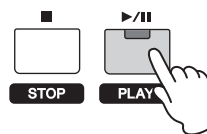

6 Play the keyboard along with the MIDI data.

The selected Part is sounded. To change the Part for playing, press [PART SELECT] to select one of the 16 Parts with the numbered Category buttons.

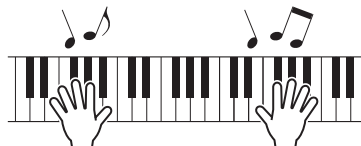

7 To pause the MIDI data, press [▶/||] (Play/Pause). To resume playback, press [▶/||] (Play/Pause) again.

8 If you wish to change the tempo, press [TEMPO], then rotate the [Data] dial to select the desired value.



NOTE This tempo setting is automatically reflected to the Arpeggio tempo and Rhythm Pattern tempo, and can be set for each Performance.

Tap Tempo function

The tempo can also be set by “playing” or tapping the [TEMPO] button several times repeatedly at the desired tempo.

9 Press [■] (Stop) to stop the MIDI data.

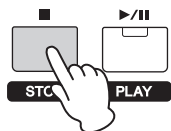

Playing back audio data of the USB flash memory

1 Connect the USB flash memory in which the audio data is stored.

NOTE Make sure that the desired audio data is stored in the root directory (which is called up when you first open the memory location) of the USB flash memory.

2 Press [EXT. SONG].

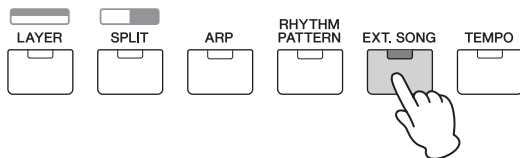

3 Press the Cursor [^] button repeatedly if necessary to call up the 1st page, then rotate the [DATA] dial to select the desired audio data.

Current elapsed time of audio data (in minutes and seconds)



Name of the audio data

4 Press the Cursor [v] button repeatedly if necessary to call up the 2nd page, then rotate the [DATA] dial to adjust the volume for the audio data.

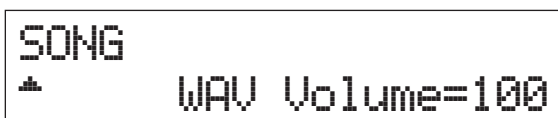

5 Press [▶/||] (Play/Pause).

The lamp of [▶/||] (Play/Pause) flashes and the selected audio data is played back.

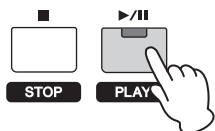

6 Play the keyboard along with the audio data.

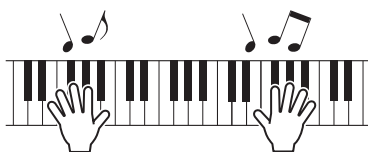

7 To pause the audio data, press [▶/||] (Play/Pause). To resume playback, press [▶/||] (Play/Pause) again.

8 Press [■] (Stop) to stop the audio data.

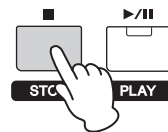

Precautions when using the USB [TO DEVICE] terminal

This instrument features a built-in USB [TO DEVICE] terminal. When connecting a USB flash memory to the terminal, be sure to handle the USB flash memory with care. Follow the important precautions below.

NOTE For more information about the handling of USB flash memories, refer to the owner's manual of your particular USB flash memory.

Compatible USB devices

Only USB memory devices of the flash-memory variety can be used with the instrument. Furthermore, the instrument does not necessarily support all commercially available USB flash memories, nor can Yamaha guarantee operation of USB devices that you purchase. Before purchasing a USB flash memory for use with this instrument, please visit the following web page: <https://download.yamaha.com/>

Connecting USB flash memories

When connecting a USB flash memory to the USB [TO DEVICE] terminal, make sure that the connector on the device is appropriate and that it is connected in the proper direction.

NOTICE

- Avoid connecting or disconnecting the USB flash memory during playback, file management (such as Save, Copy, Delete and Format operations) or while the instrument is accessing the USB flash memory in any way. Failure to do so may result in "freezing" of the operation of the instrument or corruption of the USB flash memory and the data.
- When connecting then disconnecting the USB flash memory (and vice versa), make sure to wait a few seconds between the two operations.

- NOTE**
- When connecting a USB cable, make sure that the length is less than 3 meters.
 - Though the instrument supports the USB 1.1 standard, you can connect and use a USB 2.0 flash memory with the instrument. However, note that the transfer speed is that of USB 1.1.
 - The rating of the USB [TO DEVICE] terminal is a maximum of 5V/500mA. Do not connect USB devices having a rating above this, since this can cause damage to the instrument itself.

Using USB flash memories

By connecting the instrument to a USB flash memory, you can save data you've created to the connected device, as well as read data from the connected device.

■ Number of USB flash memories that can be used

Only one USB flash memory can be connected to the [USB TO DEVICE] terminal simultaneously.

■ Formatting USB flash memories

When a USB flash memory is connected, a message may appear prompting you to format the device/media. If so, execute the Format operation (page 31).

■ NOTICE

The Format operation overwrites any previously existing data. Make sure that the media you are formatting does not contain important data.

■ To protect your data (write-protect)

To prevent important data from being inadvertently erased, apply the write-protect provided with the flash memory device. If you want to save data to the USB flash memory, make sure to disable write-protect.

■ Turning off the instrument

When turning off the instrument, make sure that the instrument is NOT accessing the USB flash memory by playback or file management (such as during Save, Copy, Delete and Format operations). Failure to do so may corrupt the USB flash memory and the data.

2 Press the play button on the connected music player.

The song data of the music player is played back from the instrument.

NOTE Use the external device's volume control to adjust the desired level balance with this instrument.

3 Play the keyboard along with the song data.

4 After finishing, press the stop button on the music player.

HINT

You can use the convenient Tap Tempo function to match Arpeggio tempo to the song data being played back from the portable music player. To do this, simply "play" or tap the [TEMPO] button several times repeatedly with the song data.

Creating an original Performance

In Performance Edit, you can edit both the parameters unique to each Part (Part Edit) and parameters common to all Parts (Common Edit). You can also edit the Voice parameters which are assigned to each Part of the Performance (Voice Edit). Edit these parameters to create an original Performance.

NOTE For details about all parameters, see the "Reference Manual" PDF document.

NOTE Preset Performances have their default settings such as Voice settings and the note range limits. Initializing Performances is useful when creating a completely new Performance from scratch. For details, see the "Reference Manual" PDF document.

Selecting the Reverb/Chorus type (Common Edit/Part Edit)

1 Press [EDIT].

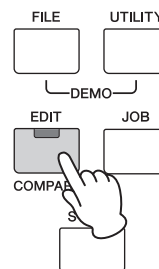

2 Press the Cursor [^] button if necessary to select "01: Common," then press [ENTER].

The Performance Common Edit display is called up.

```
EDIT
^01: Common
```

Playing back song data of a portable music player

1 Connect a portable music player to the [AUX IN] jack of this instrument.

- NOTE**
- Whenever connecting other devices, ensure that the cables you use have plugs that match the input or output connectors on those devices.
 - Before making connections, you should also turn the volume on the other devices to the minimum.

Rear Panel

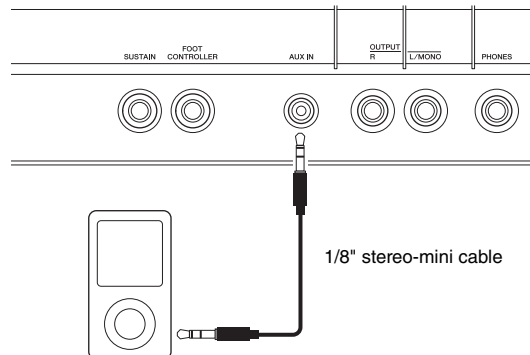

Portable music player, etc.

- 3 Press the Cursor [^] button if necessary to select “01:Chorus Eff,” then press [ENTER].**
The Chorus effect setting display is called up.



- 4 Press the Cursor [^] buttons repeatedly if necessary to call up the 1st page, then use the Cursor [<]/[>] buttons and the [DATA] dial to change the Chorus effect category/type.**

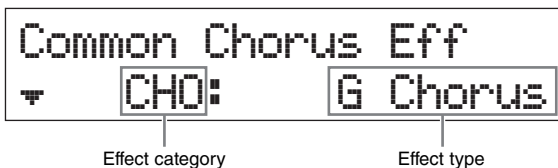

- 5 Press the Cursor [v] button to call up the 2nd page, then rotate the [DATA] dial to select a preset for the effect parameters of the selected effect type.**

Each preset type contains optimum settings for various parameters, letting you select a general “feel” you want and have the parameters set accordingly.

NOTE You can also edit each effect parameter in the 3rd or later pages. For details about each parameter, see the “Synthesizer Parameter Manual” PDF document.

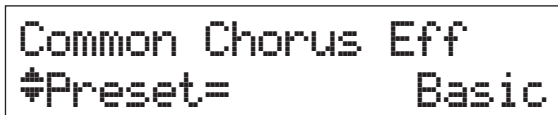

- 6 When you have finished making Chorus effect settings, press [EXIT], then press the Cursor [v] button to select “02:Reverb Eff.” Finally, press [ENTER].**
The Reverb effect display is called up.



- 7 Press the Cursor [^] button to call up the 1st page, then rotate the [DATA] dial to change the Reverb effect type**



- 8 Press the Cursor [v] button to call up the 2nd page, then rotate the [DATA] dial to select a preset for the effect parameters of the selected effect type.**

NOTE You can also edit each effect parameter in the 3rd or later pages. For details about each parameter, see the “Synthesizer Parameter Manual” PDF document.



- 9 When you have finished making Reverb effect settings, press [EXIT] two times, then press the Cursor [v] button to select “02:Part.” Finally, press [ENTER].**

The Performance Part Edit display is called up.

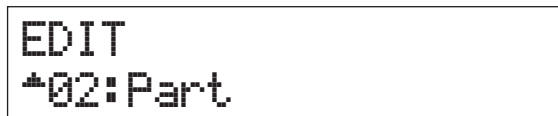

- 10 Press the Cursor [^] button repeatedly if necessary to select “01:Play Mode,” then press [ENTER].**



- 11 Press the desired Category button to select the edited Part.**

The selected Part number is shown in the upper left corner of the display.

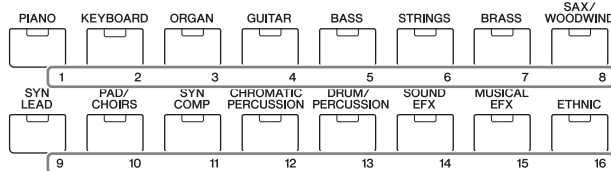

- 12 Use the Cursor [^]/[v] buttons to select “ChoSend” and “RevSend” in 5th and 6th pages, then rotate the [DATA] dial to adjust the parameter settings.**

These parameters set the depth of Chorus/Reverb effects applied to the selected Part sound.

HINT

Performance Edit indicator

When editing Performance parameters, a dot (.) is shown in the lower right of the [PERFORMANCE NUMBER] display. This provides a quick confirmation that the current Performance has been modified but not yet stored. When you want to store the current status, execute the Performance store function (page 29). After storing, this indication will be gone.

PERFORMANCE NUMBER



Changing the Insertion Effect of the Voice (Voice Edit)

You can edit parameters of the Voice assigned to each Part. The Voice parameters are in the Voice Edit displays (those having “Voice” or “DrumKit” indications in the display names). In this example, we’ll change the Insertion effect settings.

1 Press [EDIT].

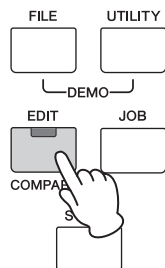

2 Press the Cursor [V] button to select “02:Part,” then press [ENTER].

The Part Edit display is called up.

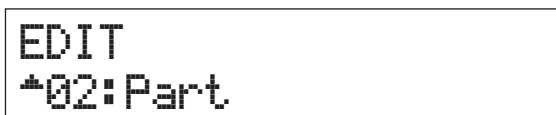

3 Press a Category button to select the desired Part.

The selected Part number is shown in the upper left of the display.

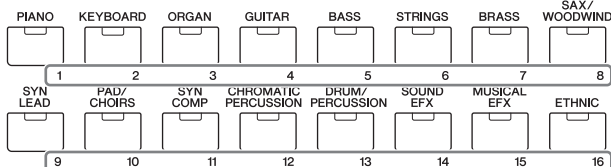

4 Press the Cursor [^] button to select “01:Play Mode,” then press [ENTER].

5 Use the Cursor [^]/[V] buttons to select “InsSw,” then rotate the [DATA] dial to set the parameter to on.

NOTE This instrument features four Insertion Effects, which can be applied to up to four Parts of the Performance.



6 Press [EXIT], then use the Cursor [^]/[V] buttons to select “05:Voice Insert Eff”/”06:Drumkit Ins Eff.” Finally, press [ENTER].

The Insertion effect display of the Voice Edit is called up.



7 Press the Cursor [^] button repeatedly if necessary to call up the 1st page, then use the Cursor [<]/[>] buttons and the [DATA] dial to change the effect type.



8 Press the Cursor [V] button to call up the 2nd page, then select a preset for the Effect parameters of the selected Effect type.

Each preset type contains optimum settings for various parameters, letting you select a general “feel” you want and have the parameters set accordingly.

NOTE You can also edit each effect parameter in the 3rd or later pages. For details about each parameter, see the “Synthesizer Parameter Manual” PDF document.



9 If you want to change the Insertion effect of another Part, press a numbered Category button to select the desired Part (as in step 3 above), then follow steps 4 to 8 again after pressing [EXIT].

NOTE You can also change Parts by pressing a numbered Category button on the Insertion effect display of Voice Edit.

Changing the Controller Set for the Voice (Voice Edit)

You can assign different functions for the controllers (Knobs, Modulation Wheel, etc.) to each Voice. Each Voice can have up to six sets which determine the available controllers for the Voice and their functions. The controller assignments are called a “Controller Set.” In this example, we’ll change the Controller Set of the Voice assigned to the Part.

1 Press [EDIT].

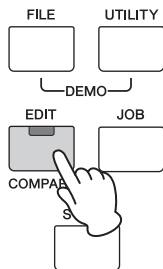

2 Press the Cursor [V] button to select “02:Part,” then press [ENTER].

The Performance Part Edit display is called up.

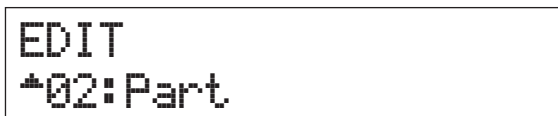

3 Press a Category button to select the desired Part.

The selected Part number is shown in the upper left of the display.

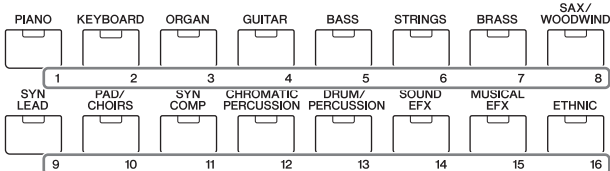

4 Use the Cursor [^]/[V] buttons to select “07:Voice Ctrl Set” or “06:Drumkit Ctrl Set,” then press [ENTER].

The Voice Edit Controller Set display is called up.



5 Use the Cursor [^]/[V] buttons to select a Controller Set from Controller Sets 1 – 6, then press [ENTER].

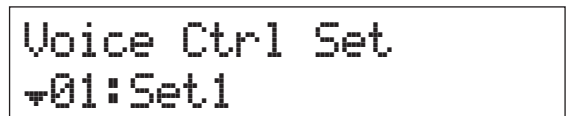

6 Press the Cursor [^] button repeatedly if necessary to call up the 1st page, then rotate the [DATA] dial to select the desired Controller.

NOTE For details about the settings, see the “Reference Manual” PDF document.



7 Press the Cursor [V] button to call up the 2nd page, then rotate the [DATA] dial to select the desired function to be assigned to the selected Controller.

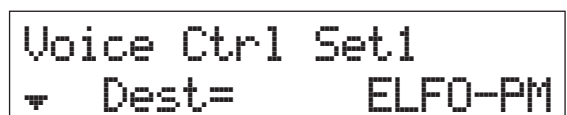

8 Press the Cursor [V] button to call up the 3rd page, then adjust the depth for the Controller’s function.

9 If you wish to change other Controller Sets, repeat steps 5 to 8 above after pressing [EXIT].

10 If you wish to change Controller Sets for other Parts, press a numbered Category button to select the desired Part, then follow steps 5 to 9 above again.

HINT Voice Edit indicator



When editing Voice parameters, an  (Edit) indicator is shown in the upper right of the display. This provides a quick confirmation that the Voice assigned to a Part has been modified but not yet stored. When you want to store the current status, execute the Voice Store function (page 29). After storing, this indication disappears.

Storing a Voice (Voice Store)

The edited Voice parameters can be stored as a User Voice separately from a Performance. Moreover, these stored User Voices can be assigned to a different Part or Performance.

NOTE If you execute Performance Store, the edited Voice data will not be stored; make sure to store the Voice using Voice Store.

- 1 When the Voice Edit display is shown, press [EXIT], then press the Cursor [V] button to select "08:Voice Name." After that, press [ENTER].

When the top display is shown, follow the instructions below.

[EDIT] → Select "02:Part" → [ENTER] → Select "08:Voice Name" → [ENTER]

```
Part01
*08:Voice Name
```

- 2 Enter an original name for the Voice before storing it.

For instructions on entering a name, see "Naming" (page 13) in "Basic Operations and Displays."

```
Voice Name
[CncrtGrand]
```

- 3 Press [STORE].



- 4 Determine the User Voice number as the store destination, and press [ENTER].

Voice Store display

```
STORE Voice
U001:Initialize
```

- 5 Press [INC/YES].

The Voice data is stored, and operation returns to the Part Edit display. To return to the top display, press [EXIT] several times. To cancel the Store operation, press [DEC/NO].

```
( Are you sure? )
( [NO]/[YES] )
```

Storing a Performance (Performance Store)

When you are satisfied with the Performance you've created, store the new settings to internal memory (as a Performance).

■ NOTICE ■

If you execute Performance Store while the Voice has been modified but not yet stored, the edited Voice and all recent changes you made to it will be erased. Make sure to store important Voice data as a User Voice (Voice Store) before storing the Performance.

- 1 Press [EDIT] to select "01:Common," then press [ENTER]. After that, select "06:Name," then press [ENTER].

- 2 Enter an original name for the Performance before storing it.

For instructions on entering a name, see "Naming" (page 13) in "Basic Operations and Displays."

```
Common Name
[MXPerf01 ]
```

- 3 Press [STORE].



- 4 Determine the Performance number as the store destination, and press [ENTER].

■ NOTICE ■

Keep in mind that the destination Performance will be overwritten and lost by executing Performance Store.

Performance Store display

```
STORE Performance
001(A01):MXCategory
```

- 5 Press [INC/YES].

The Performance data is stored, and operation returns to the top display. To cancel the Store operation, press [DEC/NO].

```
( Are you sure? )
( [NO]/[YES] )
```

Changing Voices smoothly while performing

When you change a Voice assigned to a Part or select a different Performance, the sound of the previous Voice/Performance will be cut off, replaced abruptly by the newly selected Voice/Performance.

In live performance situations, you probably want to avoid this. To change Voices as you play without having them cut off, assign the Voices you intend to play beforehand to Parts 1 – 16 of a Performance, then select the corresponding Part (with the numbered Category buttons) as you play.

1 Press [PART SELECT].

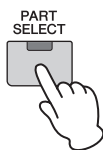

2 Press the Cursor [^] button several times to call up the 1st page.

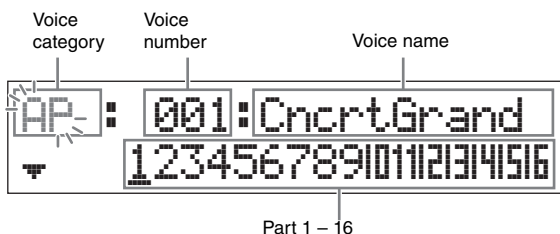

3 Use the Category buttons or the Cursor [<]/[>] buttons to select the desired Part from Parts 1 – 16.

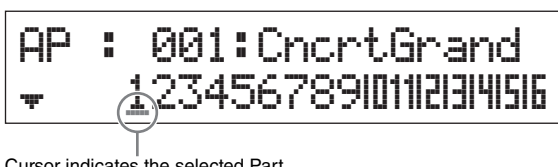

Cursor indicates the selected Part

4 Rotate the [DATA] dial to change the Voice category for the selected Part.

5 Press the Cursor [v] button to call up the 2nd page, then rotate the [DATA] dial to select the Voice from the current Voice category.

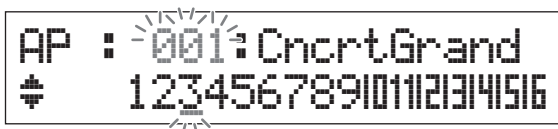

NOTE You can also edit other Part parameters in the 3rd or subsequent pages. For details about each parameter, see the "Reference Manual" PDF document.

6 To change Voices for other Parts, repeat steps 2 to 5 above.

NOTE You can also change Parts with the Category buttons or the Cursor [<]/[>] button in pages other than the 1st page.

7 When you have finished making settings for the Parts, select different Voices (Parts) by using the Category buttons or the Cursor [<]/[>] buttons, while playing the keyboard.

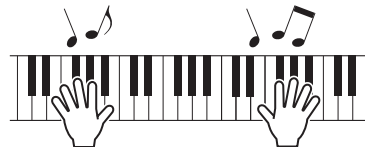

8 Store the Voice assignments as a Performance to internal memory so you can instantly call them up whenever you want.

For details about storing, see the "Storing the Performance" (page 29).

HINT

Applying Insertion effects to desired Parts

Insertion effects can be independently applied to up to four Parts (maximum) to which the desired Voices for live performance are assigned. For details about the settings, see "Changing the Insertion Effect of the Voice" (page 27).

Making Global System Settings (Utility settings)

Pressing [UTILITY] calls up the Utility display, from which you can make global system settings.

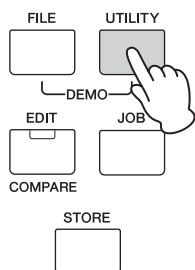

Changing the Master Tune setting

This function sets the overall tuning of the instrument.

- 1 Press the Cursor [^] button repeatedly if necessary to select “01:General,” then press [ENTER].
- 2 Use the Cursor [^]/[V] buttons to select the “Tune” parameter, then rotate the [DATA] dial to change the value.

The pitch is changed in cent increments.

NOTE The frequency of the basic pitch (note A3) is 440 Hz. An increase of 3 or 4 cents corresponds to a frequency increase of about 1 Hz.

```
UTILITY General
#Tune=+ 0.0/440.0Hz
```

- 3 Press [STORE].
All Utility settings are stored.

Adjusting the brightness of the display (LCD Contrast)

- 1 Press the Cursor [^] button repeatedly if necessary to select “01:General,” then press [ENTER].
- 2 Use the Cursor [^]/[V] buttons to select the “LCD Contrast” parameter, then rotate the [DATA] dial to change the value.

```
UTILITY General
# LCD Contrast=5
```

- 3 Press [STORE].
All Utility settings are stored.

NOTE Adjusting the display brightness

To adjust the brightness of the display, simultaneously hold down [UTILITY] and press [INC/YES]/[DEC/NO].

For details about the Utility settings, see the “Reference Manual” PDF document.

Saving/loading files on USB flash memory (File settings)

You can save the created Performances and Voices to USB flash memory, and load data from the USB flash memory.

Formatting the USB flash memory

Some USB flash memories may not be supported by this instrument. In this case, follow the instructions below to format the memory before using it.

■ **NOTICE** ■

If data is already saved to the USB flash memory, be careful not to format it. If you format the device, all previously recorded data will be deleted. Make sure to check beforehand whether or not the device contains important data.

- 1 Connect the USB flash memory to the USB [TO DEVICE] terminal.
- 2 Press [FILE] to call up the File display.
- 3 Use the Cursor [^]/[V] buttons to select “05:Format,” then press [ENTER].
A confirmation message appears. If you wish to cancel the Format operation, press [EXIT].
- 4 Press [INC/YES] to execute the Format operation.
After formatting has been completed, a “Completed” message appears and operation returns to the original display.

■ **NOTICE** ■

While formatting is in process, do not remove or disconnect the USB flash memory from the instrument. Also, make sure to keep the power of the instrument on until the operation is finished.

NOTE By executing the Format operation in the File mode, the USB flash memory will be formatted to MS-DOS or Windows format. The formatted device may not be compatible with other devices, such as a Mac computer or digital camera.

Saving settings to USB flash memory

You can save all data of the User memory—containing Performances, created User Voices, and Utility settings—to USB flash memory as an “All” file (extension: .X5A).

- 1 Connect a USB flash memory to the USB [TO DEVICE] terminal.
- 2 Press [FILE].

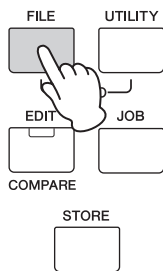

- 3 Press the Cursor [^] buttons several times to select “01:Save,” then press [ENTER].



- 4 Assign a name to the file.

For instructions on entering a name, see “Naming” (page 13) in “Basic Operations and Displays.”

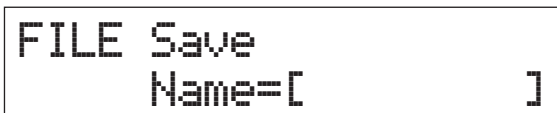

- 5 Press [ENTER].

- 6 Press [INC/YES].

The file is saved to the USB flash memory. To cancel the Save operation, press [EXIT] while the “Now saving...” message is still displayed.

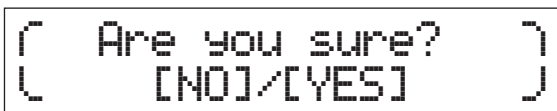

- 7 Press [EXIT] several times to exit from the File display.

Loading the settings from a USB flash memory

- 1 Connect the USB flash memory to the USB [TO DEVICE] terminal.
- 2 Press [FILE].

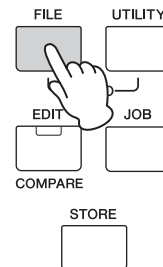

- 3 Use the Cursor [^]/[V] buttons to select “02:Load,” then press [ENTER].

Any “All” files that are contained in the USB flash memory appear in the display.

NOTE If no “All” files are stored in the root directory of the USB flash memory, a “File not found” message appears and the Load display cannot be called up.



- 4 Select the desired file, then press [ENTER].



- 5 Select the desired data type of the selected “All” file, then press [ENTER].

Select the desired type: all data (All), all data except for the Utility settings (All without Sys), or Performance data only (Performance).



- 6** If you've set "Type" to "Performance" in step 5, select the desired Performance number, then press [ENTER].

If you've set "Type" to something other than "Performance" in step 5, go on to step 8.

```
Src Performance
001(A01):MXCategory
```

- 7** Select the destination Performance number (for loading), then press [ENTER].

```
Dst Performance
003(A03):Sirius
```

- 8** Press [INC/YES].

The data is loaded from the USB flash memory. To cancel the Load operation, press [EXIT] while the "Now loading..." message is still displayed.

```
( Are you sure? )
( [NO]/[YES] )
```

- 9** Press [EXIT] repeatedly if necessary to exit from the File display.

Connecting an external MIDI instrument

With a standard MIDI cable (available separately), you can connect an external MIDI instrument, and transmit MIDI data between the instrument and the connected instrument.

Either the MIDI connectors or the USB [TO HOST] terminal can be used for MIDI data transmission/reception; however, they cannot be used at the same time. Select the desired connector for use in the "MIDI IN/OUT" parameter of the [UTILITY] → "02:MIDI" display. As you work through the explanations in this chapter, set "MIDI IN/OUT" to "MIDI" since MIDI is used as the example connection here.

Controlling the instrument from an external MIDI keyboard or synthesizer

Here, we'll use an external keyboard or synthesizer to remotely select and play the Voices of the instrument.

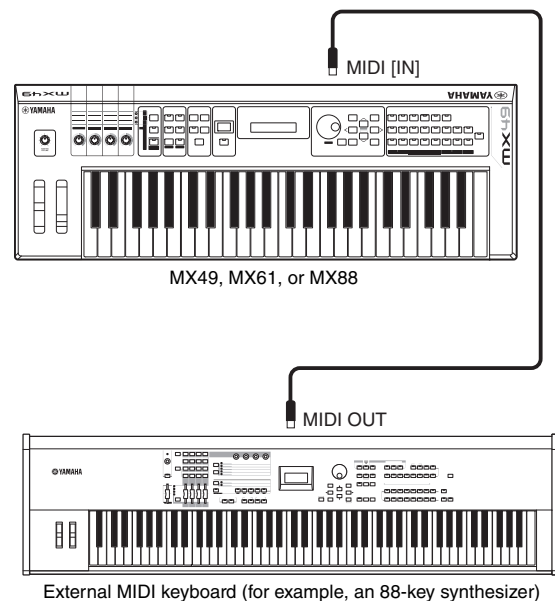

HINT**MIDI Transmit and Receive channels – Changing the Performances remotely**

The MIDI Receive channels for Parts 1 – 16 of the instrument are fixed to 1 – 16. Make sure to match the MIDI Transmit channels of the external MIDI instrument with the MIDI Receive channels of the instrument. For details on setting the MIDI Transmit channels of the external MIDI instrument, refer to the owner's manual of that instrument.

You can also use an external MIDI instrument to change this instrument's Performances with the proper program change messages. To do this, you'll need to match the MIDI Transmit channel of the external MIDI instrument with the basic MIDI Receive channel of the instrument. For details on setting the basic MIDI Receive channel of the instrument, follow the instructions below.

- 1 Press [UTILITY].**
- 2 Use the Cursor [^]/[v] buttons to select "02:MIDI," then press [ENTER].**
- 3 Use the Cursor [^]/[v] buttons to select "BasicCh (Basic Channel)," then check the channel.**

If necessary, change the channel to the same channel as the MIDI transmit channel of the external MIDI instrument.

HINT**MIDI Transmit and Receive Channels – Sounding only an external tone generator**

The MIDI Receive channels for Parts 1 – 16 of the instrument are fixed to 1 – 16. Make sure to match the MIDI Receive channels of the external MIDI instrument with the MIDI Transmit channels of the instrument. For details on setting the MIDI Transmit channels of the external MIDI instrument, refer to the owner's manual of that instrument.

You can also control an external tone generator from the instrument and have only that device sound. To do this, set the [MASTER VOLUME] knob to "0" or set the Local Control to "off" with the following operation: [UTILITY] → Select "02:MIDI" → [ENTER] → "LocalCtrl" = "off."

Controlling an external MIDI keyboard or synthesizer from the instrument

This connection lets you sound an external MIDI tone generator (synthesizer, tone generator module, etc.) by playing the instrument or playing back a Song or Pattern of the instrument. Use this connection when you wish to sound the other instrument along with the instrument.

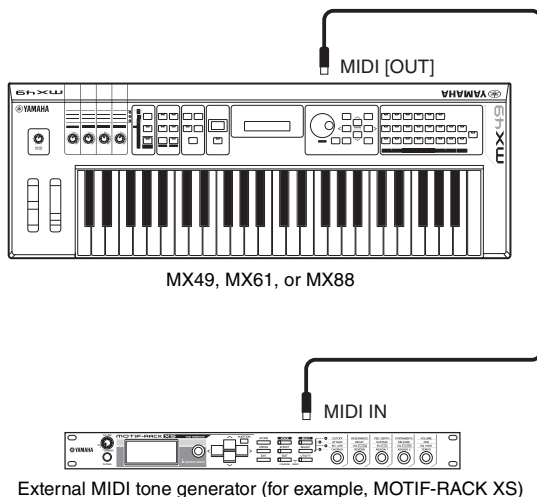

Appendix

Shift Function List

Some of the important functions and operations on the instrument can be executed with convenient panel control shortcuts. Simply hold down the [SHIFT] button and press the indicated button (as described below).

| Operation | Function |
|-----------------------------------|---|
| [SHIFT] + [INC]/[DEC]/[DATA] dial | Increases/decreases the value by 10. (Program number in the Play mode; parameter value in the Edit mode) In the Performance Select display, this switches among the Performance groups. |
| [SHIFT] + [SPLIT] | In the Performance top display, this replaces Part 1 with Part 2 (Invert function). |
| [SHIFT] + [LAYER] | In the Performance top display, this copies a selected Part (Part 1 or Part 2) to the other Part (Unison function). |
| [SHIFT] + [EXIT] | Calls up the Performance top display. |
| [SHIFT] + [SELECT] | Resets Performance 1 to the factory settings, and calls up the top display of Performance 1 (Quick Reset function). |
| [SHIFT] + [KNOB FUNCTION] | Instantly resets Knobs [A] – [D] to Function 1. |
| [SHIFT] + [PART 1-2 LINK] | Resets [PART 1-2 LINK] to on. |
| [SHIFT] + [ARP] | Calls up the Arpeggio display of Performance Part Edit. |
| [SHIFT] + desired Category button | In the Performance top display, this instantly calls up the Voice in the next Sub Category of the selected Category. Perform this operation with the same Category button repeatedly to select the subsequent Sub Categories. In the Performance Select display, this selects the corresponding Performance among Performances 1 – 16 in the selected Performance group. NOTE For details about Sub Categories, see the "DATA LIST" PDF document |

Display Messages

| LCD indication | Description |
|------------------------------|---|
| All remote templates stored. | Appears when you store the Control Template in the Remote mode. |
| Are you sure? | Confirms whether you want to execute a specified operation or not. |
| Auto power off disabled. | Appears when Auto Power Off is disabled (by simultaneously holding down the lowest key on the keyboard and turning the power on). |
| Bulk protected. | Bulk data cannot be received because of the Utility setting. |
| Clear edit Voice? | Appears when executing Performance Store while modifying but not yet having stored a Voice. Make sure to confirm whether the edited Voice data should be erased or not. |
| Completed. | The specified load, save, format, or other Job has been completed. |
| Connecting USB device . . . | Currently recognizing the USB flash memory connected to the USB [TO DEVICE] terminal. |
| Device number is off. | Bulk data cannot be transmitted/received since the device number is off. |
| Device number mismatch. | Bulk data cannot be transmitted/received since the device numbers don't match. |
| Executing . . . | A Format operation or Job is being executed. Please wait. |
| FactorySet . . . | The Factory Set operation is automatically being executed when you turn the power on. |
| File already exists. | A file having the same name as the one you are about to save already exists. |
| File not found. | The file of the specified type cannot be found. |
| Illegal file name. | The specified file name is invalid. Try entering a different name. |

| LCD indication | Description |
|------------------------------------|---|
| Illegal file. | The file specified for loading is unusable by this instrument or cannot be loaded in the current status. |
| Illegal format. | The format of the file specified for playback is SMF Format 1 or an audio data format other than WAV. Use SMF Format 0 MIDI data or WAV format audio data. |
| Incompatible USB device. | A USB device which cannot be used with this instrument has been connected to the USB [TO DEVICE] terminal. |
| Invert | Appears when replacing Part 1 with Part 2 by while holding down [SHIFT] and pressing [SPLIT] (Invert function). |
| MIDI buffer full. | Failed to process the MIDI data because too much data was received at one time. |
| MIDI checksum error. | An error occurred when receiving bulk data. |
| MIDI data error. | An error occurred when receiving MIDI data. |
| No response from USB device. | There is no response from the USB device connected to the USB [TO DEVICE] terminal. |
| Now loading . . . [EXIT] to cancel | Indicates that a file is being loaded. If you wish to cancel this operation, press [EXIT] while this message appears. |
| Now saving . . . [EXIT] to cancel | Indicates that a file is being saved. If you wish to cancel this operation, press [EXIT] while this message appears. |
| Now working. . . | Canceling the Load/Save operation, after the [EXIT] button has been pressed. |
| Overwrite? | A Save operation will overwrite data on the USB flash memory, and this message prompts you to confirm whether it is OK to continue or not. |
| Please keep power on . . . | The data is being written to User memory. Never attempt to turn off the power while data is being written to User memory. Turning the power off while this message is shown results in loss of all user data and may cause the system to freeze (due to corruption of data in the User memory). This may also result in this instrument being unable to properly start up the next time the power is turned on. |
| Please stop sequencer. | The operation you have attempted to execute cannot be done during Song/Pattern playback. |
| Quick reset | Appears when while holding down [SHIFT] and pressing [SELECT]. Performance 1 is set to the factory settings, and the top display of Performance 1 is called up (Quick Reset function). |
| Receiving MIDI bulk . . . | This instrument is receiving MIDI bulk data. |
| System memory crashed. | Failed to write the data to the internal memory of this instrument. |
| This Performance uses User Voices. | Appears when the Performance specified for loading contains User Voices. User Voices cannot be loaded with the Performance. Make sure that the same User Voices used when you saved the Performance are stored at the same User Voice numbers or not, since the User Voices are not loaded with the Performance. |
| Transmitting MIDI bulk . . . | This instrument is transmitting MIDI bulk data. |
| Unison | Appears when copying Part 1/Part 2 to another Part by while holding down [SHIFT] and pressing [LAYER] (Unison function). |
| USB connection terminated. | A break in the connection with the USB flash memory has occurred because of an abnormal electric current. Disconnect the device from the USB [TO DEVICE] terminal, then press the [ENTER] button. |
| USB device full. | The USB flash memory is full and no more data can be saved. Use a new USB flash memory, or make space by erasing unwanted data from the device. |
| USB device not ready. | A USB flash memory is not properly inserted in or connected to the USB [TO DEVICE] terminal. |
| USB device read/write error. | An error occurred while reading or writing to/from a USB flash memory or attempting to delete or overwrite a read-only file. |
| USB device unformatted. | Appears when the connected USB flash memory is either unformatted or formatted in a way that this instrument does not support. In such a case, check the content of the USB flash memory. |
| USB device write protected. | The USB flash memory is write protected, or you have attempted to write to read-only media. |
| USB power consumption exceeded. | Appears when the current being drawn by the USB flash memory exceeds the level supported by this instrument. |
| USB transmission error. | An error occurred while communicating with a USB flash memory. |
| Utility stored. | The Utility settings have been stored. |

Troubleshooting

No sound? Wrong sound? When a problem like this occurs, please check the following points before assuming that the product is faulty. Many problems can be solved by executing the Factory Set operation (page 11), after backing up your data to a USB flash memory (page 32). If the problem persists, consult your Yamaha dealer.

No Sound.

- Is this instrument properly connected to related external equipment (e.g., amplifier, speaker, headphone) via audio cables?
Since this instrument has no built-in speakers, you will need an external audio system or a set of stereo headphones to properly monitor it (page 9*).
- Is the power of this synthesizer and any external equipment connected to it turned on?
- Have you made all the appropriate level settings—including the Master Volume on this instrument and the volume settings on any connected external equipment?
If a Foot Controller is connected to the [FOOT CONTROLLER] jack, operate the Foot Controller and check the sound volume.
- Check the Local Control parameter in the Utility display.
When this instrument is used by itself and this parameter is set to off, no sound is produced even if you play the keyboard.
[UTILITY] → Select "02:MIDI" → [ENTER] → "LocalCtrl"
- Check the Direct Monitor Switch parameter in the Utility display.
When this instrument is used by itself and this parameter is set to off, no sound is produced even if you play the keyboard.
[UTILITY] → Select "01:General" → [ENTER] → "DirectMonitor"
- Are the MIDI volume or MIDI expression settings too low when using an external controller?
- Are the effect and filter settings appropriate?
If you are using the filter, try changing the cutoff frequency. Some cutoff settings may filter out all of the sound.
[EDIT] → Select "02:Part" → [ENTER] → Select "02:Filter/EG" → [ENTER]
[EDIT] → Select "02:Part" → [ENTER] → Select "05:Voice Insert Eff"/"05:DrumKit Insert Eff" → [ENTER]
- Are the volume or expression settings too low?
[UTILITY] → Select "01:General" → [ENTER] → "MasterVolume"
[EDIT] → Select "01:Common" → [ENTER] → Select "05:General" → [ENTER] → "Volume"
[PART SELECT] → "Volume"

No sound from the [AUX IN] jack.

- Is the volume of the connected audio device set to a value other than "0"?

Cannot play audio data.

- Is the volume for the audio data set to a value other than "0"?
[UTILITY] → Select "01:General" → [ENTER] → "WAV Volume"
- Is the format of the audio data correct?
This instrument can play only stereo WAVE (.wav) files of 44.1kHz/16-bit.

Playback continues without stopping.

- When the [ARP] button is turned on, press it so that its lamp is turned off.
- When playing back Rhythm Pattern or Song data of the USB flash memory, press the [■] (Stop) button.

The instrument is automatically turned off even if no operation is done.

- Is the Auto Power Off function enabled?
If necessary, disable this function or change the amount of time that elapses before the power is automatically turned off.
[UTILITY] → Select "01:General" → [ENTER] → "AutoOff"

Distorted sound.

- Are the effect settings appropriate?

Use of certain effects at certain settings may produce distortion.

[EDIT] → Select "02:Part" → [ENTER] → Select "05:Voice Insert Eff"/"05:DrumKit Insert Eff" → [ENTER]

- Are the filter settings appropriate?

Excessively high filter resonance settings can cause distortion.

[EDIT] → Select "02:Part" → [ENTER] → Select "02:Filter/EG" → [ENTER]

- Are any of the following volume parameters set so high that clipping is occurring?

[UTILITY] → [EDIT] → Select "01:Common" → [ENTER] → Select "05:General" → [ENTER] → "Volume"

[PART SELECT] → "Volume"

[UTILITY] → Select "01:General" → [ENTER] → "WAV Volume"

Sound is cut off.

- Is the entire amount of notes played (via your keyboard playback and Song/Pattern/Arpeggio playback) exceeding the maximum polyphony of this instrument?

The maximum number of simultaneous notes may be less than 128 depending on the Voices used.

Only one note sounds at a time.

- When this situation occurs, the Mono/Poly parameter in the current mode is set to "mono." If you wish to play chords, set this parameter to "poly."

[EDIT] → Select "02:Part" → [ENTER] → Select "01:PlayMode" → [ENTER] → "Mono/Poly"

Pitch or intervals are wrong.

- Is the Master Tune parameter in the Utility display set to a value other than "0"?

[UTILITY] → Select "01:General" → [ENTER] → "Tune"

- Is the Note Shift parameter in the Utility display set to a value other than "0"?

[UTILITY] → Select "01:General" → [ENTER] → "NoteShift"

- Are the Note Shift and Detune parameters of each Part set to values other than "0"?

[EDIT] → Select "01:Part" → [ENTER] → Select "01:PlayMode" → [ENTER] → "NoteShift"/"Detune"

No effect is applied.

- Check the on/off status of the Insertion Effect switch.

[EDIT] → Select "02:Part" → [ENTER] → Select "01:PlayMode" → [ENTER] → "InsSw"

[PART SELECT] → "InsSw"

- Is the Reverb Send or Chorus Send set to a value other than "0"?

[EDIT] → Select "02:Part" → [ENTER] → Select "01:PlayMode" → [ENTER] → "ChoSend"/"RevSend"

- Has the Insertion Effect type for the Part been set to "thru"?

[EDIT] → Select "02:Part" → [ENTER] → Select "05:Voice Insert Eff"/"05:DrumKit Insert Eff" → [ENTER]

The Edit Indicator appears, even when parameters are not being edited.

- Keep in mind that even though the Edit mode is not active, simply moving a Knob or playing back the MIDI data of the USB flash memory may cause the Edit Indicator to appear.

Cannot start the Arpeggio.

- Check whether [ARP] is turned on or off.
- Are the Arpeggio switches for both Part and Common set to on?
 [EDIT] → Select "02:Part" → [ENTER] → Select "03:Arp Select" → [ENTER] → "Switch"
 [EDIT] → Select "01:Common" → [ENTER] → Select "04:Arp Switch" → [ENTER] → "Switch"
- Is the MIDI Sync parameter set to "internal" or "auto" (using internal clock)?

[UTILITY] → Select "02:MIDI" → [ENTER] → "MIDI Sync"

Cannot stop the Arpeggio.

- When Arpeggio playback does not stop even if you release the key, set the Arpeggio Hold parameter to "off."

[EDIT] → Select "02:Part" → [ENTER] → Select "03:Arp Select" → [ENTER] → "Hold"

The Voice produces a different sound depending on the assign destination Part or Performance.

- Depending on the effect (and other) settings for the Performance or Part, the Voice assigned to the Performance or Part may produce a different sound. If necessary, change the following parameter settings.

[EDIT] → Select "02:Part" → [ENTER] → Select "01:PlayMode" → [ENTER] → "ChoSend"/"RevSend"

[EDIT] → Select "01:Common" → [ENTER] → Select "01:Chorus Eff"/"02:Reverb Eff" → [ENTER]

[PART SELECT] → "InsSw"

[EDIT] → Select "02:Part" → [ENTER] → Select "02:Filter/EG" → [ENTER]

The Song/Pattern cannot be started even when pressing the [▶/||] (Play/Pause) button.

- When you attempt to play back the Song data, is the USB flash memory containing the data connected to this instrument?
- Is the [DAW REMOTE] button turned off?
- Is the current display something other than Utility or File?
- Is the MIDI Sync parameter set to "internal" or "auto" (using internal clock)?

[UTILITY] → Select "02:MIDI" → [ENTER] → "MIDI Sync"

Data communication between the computer and this instrument does not work properly.

- Check whether the Port settings on the computer are appropriate or not.
- Check whether the MIDI IN/OUT parameter is set to the appropriate value or not.

[UTILITY] → Select "02:MIDI" → [ENTER] → "MIDI IN/OUT"

MIDI bulk data transmission/reception does not work properly.

- Is the Receive Bulk parameter set to on?

[UTILITY] → Select "02:MIDI" → [ENTER] → "RcvBulk"

- When receiving MIDI bulk data transmitted via the Bulk Dump function and recorded to the external MIDI device, you need to set the MIDI Device Number to the same value as when transmitting.

[UTILITY] → Select "02:MIDI" → [ENTER] → "DeviceNo."

- When transmission does not work properly, is the device number of the MIDI instrument connected to this instrument set to match the Device Number Parameter in the Utility display?

[UTILITY] → Select "02:MIDI" → [ENTER] → "DeviceNo."

Cannot save data to the USB flash memory.

- Is the USB flash memory being used write protected? (Write-protect should be set to off for saving data.)
- Is the USB flash memory being used properly formatted?

[FILE] → Select "05:Format" → [ENTER] → [INC/YES]

Specifications

| | | |
|-----------------------------|---|---|
| Keyboard | MX49 | 49 keys (Initial touch) |
| | MX61 | 61 keys (Initial touch) |
| | MX88 | 88 keys, GHS keyboard (Initial touch) |
| Tone Generator block | Tone Generator | AWM2 |
| | Polyphony | 128 (max.) |
| | Multi-timbral Capacity | 16 parts (Internal) |
| | Wave | Approx. 166 MB (when converted to 16-bit linear format) |
| | Voice | Preset: 1,106 Normal Voices + 61 Drum Kits (GM: 128 Normal Voices + 1 Drum Kit) User: 128 Normal Voices + 8 Drum Kits |
| | Performance | User: 128 (16 parts) |
| | Effect System | Reverb x 9 types (42 presets), Chorus x 17 types (88 presets), Insertion Effect x 48 types (267 presets) x 4, Master EQ (5 bands) |
| Sequencer block | Sequence Play | SMF Format 0 (playback only) |
| | Tempo (BPM) | 5 – 300 |
| | Rhythm Pattern | 208 Patterns |
| | Song | 27 Demo Songs |
| | Arpeggio | 999 types |
| Others | Sequence software compatible with the Remote Control function | For Windows [®] : Cubase 8 or later, SONAR X2 Producer For Mac [®] : Cubase 8 or later, Logic Pro X, Digital Performer 9 *Functions to be controlled differ depending on the software |
| | Controllers | Pitch Bend Wheel x 1, Modulation Wheel x 1, Assignable Knob x 4, [DATA] dial x 1 |
| | Display | 3 digit LED + 20 x 2 line character LCD (backlit) |
| | Connectors | OUTPUT [L/MONO]/[R] (6.3 mm, standard phone jack), [PHONE] (6.3 mm, standard stereo phone jack), [FOOT CONTROLLER], [SUSTAIN], MIDI [IN]/[OUT], USB [TO HOST]/[TO DEVICE], [AUX IN], DC IN |
| | Power Consumption | 9W (When using PA-150 AC adaptor) |
| | Standby Power Consumption | 0.3 W |
| | Dimensions, Weight | MX49: 830(W) x 298(D) x 91(H) mm (32-11/16" x 11-3/4" x 3-9/16"), 3.8kg (8 lbs., 6 oz.) MX61: 984(W) x 299(D) x 112(H) mm (38-3/4" x 11-3/4" x 4-7/16"), 4.8kg (10 lbs., 9 oz.) MX88: 1320(W) x 405(D) x 168(H) mm (52" x 15-15/16" x 6-5/8"), 13.9kg (30 lbs., 10 oz.) |
| | Accessories | AC adaptor (PA-150 or an equivalent recommended by Yamaha), Owner's Manual (this book), Cubase AI Download Information |

The contents of this manual apply to the latest specifications as of the publishing date. To obtain the latest manual, access the Yamaha website then download the manual file. Since specifications, equipment or separately sold accessories may not be the same in every locale, please check with your Yamaha dealer.

GM Voice

GM (General MIDI) is a worldwide standard for Voice organization and MIDI functions of synthesizers and tone generators. It was designed primarily to ensure that any Song data created with a specific GM device would sound virtually the same on any other GM device—no matter the manufacturer or the model. The GM Voice bank on this synthesizer is designed to appropriately play back GM Song data. However, keep in mind that the sound may not be exactly the same as played by the original tone generator.

Index

A

| | |
|-------------------------------|-------|
| [ARP] button | 7, 19 |
| Arpeggio | 18 |
| Audio data | 23 |
| Auto Power Off function | 10 |
| [AUX IN] jack | 8, 25 |

B

| | |
|---------------------------------|--------|
| Brightness of the display | 10, 31 |
|---------------------------------|--------|

C

| | |
|---|-------|
| Category | 14 |
| Chorus | 25 |
| Common Edit | 25 |
| Connection (External MIDI instrument) | 33 |
| Controller Set | 28 |
| Controllers | 17 |
| Cursor | 12 |
| Cursor buttons | 7, 12 |

D

| | |
|---------------------------|-------|
| [DATA] dial | 7, 12 |
| [DAW REMOTE] button | 6 |
| DC IN jack | 8, 9 |
| [DEC/NO] button | 7, 12 |
| Demo Song | 10 |

E

| | |
|--------------------------|---------------|
| [EDIT] button | 6, 25, 27, 28 |
| Edit indicator | 26, 28 |
| Effect | 25, 27 |
| [ENTER] button | 7 |
| [EXIT] button | 7, 13 |
| [EXT. SONG] button | 7, 23 |

F

| | |
|---------------------------------------|-------|
| Factory settings | 11 |
| [FILE] button | 6, 31 |
| File settings | 31 |
| Foot controller | 18 |
| [FOOT CONTROLLER] jack | 8, 18 |
| Footswitch | 18 |
| Formatting the USB flash memory | 31 |

H

| | |
|----------------------------|----|
| Half-damper function | 18 |
| Headphones | 9 |

I

| | |
|--------------------------------|-------|
| [INC/YES] button | 7, 12 |
| Initial factory settings | 11 |
| Inputting characters | 13 |
| Insertion Effect | 27 |
| Invert function | 35 |

J

| | |
|--------------------|---|
| [JOB] button | 6 |
|--------------------|---|

K

| | |
|------------------------------|-------|
| Key On Start function | 21 |
| [KNOB FUNCTION] button | 6, 17 |
| Knobs [A] – [D] | 6, 17 |

L

| | |
|----------------------|--------|
| Layer | 15 |
| [LAYER] button | 7, 15 |
| LCD | 7 |
| LCD Contrast | 10, 31 |
| List | 12 |
| Load | 32 |

M

| | |
|--|-------|
| Master Tune | 31 |
| [MASTER VOLUME] knob | 6, 10 |
| MIDI data | 23 |
| MIDI [IN]/[OUT] terminals | 8, 33 |
| MIDI Transmit and Receive channels | 34 |
| Modulation wheel | 6, 17 |

N

| | |
|--------------|----|
| Naming | 13 |
|--------------|----|

O

| | |
|---------------------------------|-------|
| OCTAVE [-]/[+] buttons | 6, 20 |
| OUTPUT [L/MONO]/[R] jacks | 8, 9 |

P

| | |
|------------------------------------|-----------|
| Page | 13 |
| Part | 20 |
| [PART 1-2 LINK] button | 6, 17 |
| Part Edit | 25 |
| [PART SELECT] button | 7, 30 |
| Pedal | 18 |
| Performance | 20 |
| [PERFORMANCE NUMBER] display | 7, 20 |
| Performance Select display | 20 |
| Performance Store | 29 |
| [PHONES] jack | 8, 9 |
| Pitch Bend wheel | 6, 17 |
| [▶/] (Play/Pause) button | 6, 21, 23 |
| Power supply | 9 |

Q

| | |
|----------------------------|--------|
| Quick Reset function | 14, 35 |
|----------------------------|--------|

R

| | |
|-------------------------------|-------|
| Reverb | 25 |
| Rhythm Pattern | 21 |
| [RHYTHM PATTERN] button | 7, 22 |

S

| | |
|----------------------------------|-------|
| Save | 32 |
| [SELECT] button | 7, 20 |
| [SHIFT] button | 7, 35 |
| SMF | 23 |
| Song | 23 |
| Speaker | 9 |
| Split | 16 |
| [SPLIT] button | 7, 16 |
| Standby/On switch | 8, 9 |
| [■] (Stop) button | 6 |
| Stopping Arpeggio playback | 15 |
| Store | 29 |
| [STORE] button | 6, 29 |
| Storing the Rhythm Pattern | 22 |
| Sustain function | 18 |
| [SUSTAIN] jack | 8, 18 |

T

| | |
|---------------------------------|---------------|
| Tap Tempo function | 19, 22, 23 |
| Tempo | 19, 22, 23 |
| [TEMPO] button | 7, 19, 22, 23 |
| Transport buttons | 6 |
| TRANSPOSE [-]/[+] buttons | 6, 20 |

U

| | |
|--------------------------------|------------|
| Unison function | 35 |
| USB flash memory | 23, 24, 31 |
| USB [TO DEVICE] terminal | 8, 24, 31 |
| [UTILITY] button | 6, 31 |
| Utility settings | 31 |

V

| | |
|-----------------------------|--------|
| Voice | 14 |
| Voice Category | 14 |
| Voice Category button | 7, 14 |
| Voice Edit | 27, 28 |
| Voice Store | 29 |
| Volume | 10 |

W

| | |
|------------------|----|
| WAV Volume | 24 |
| Wave file | 23 |

Important Notice: Power management information for customers in European Economic Area (EEA), Switzerland and Turkey

Remarque importante : Informations sur la gestion de l'alimentation pour les clients de l'Espace économique européen (EEE), de Suisse et de Turquie

| | |
|---|--------------------|
| Yamaha products are equipped with a power management function. Some products allow you to disable that function, or to extend the amount of time that elapses before the power is turned off or set to standby. In these cases, energy consumption will increase. | English |
| Yamaha-Produkte sind mit einer Power-Management-Funktion ausgestattet. Bei einigen Produkten können Sie diese Funktion ausschalten oder die Zeitdauer, die verstreicht, bis das Instrument ausgeschaltet oder in Bereitschaft versetzt wird, verlängern. In diesen Fällen erhöht sich der Energieverbrauch. | Deutsch |
| Les produits Yamaha sont équipés d'une fonction de gestion de l'alimentation. Certains produits vous permettent de désactiver cette fonction ou d'allonger le délai avant la mise hors tension ou la mise en veille. Dans ces cas, la consommation d'énergie augmente. | Français |
| Yamaha-producten zijn uitgerust met een energiebeheerfunctie. Bij sommige producten kunt u die functie uitschakelen of de tijd verlengen die verstrijkt voordat de stroom wordt uitgeschakeld of in stand-by wordt gezet. In deze gevallen zal het energieverbruik toenemen. | Nederlands |
| Los productos Yamaha están equipados con una función de administración de energía. Algunos productos permiten desactivar esa función o ampliar el tiempo que transcurre antes de apagar la alimentación o poner el producto en modo de espera. En estos casos, el consumo de energía aumentará. | Español |
| I prodotti Yamaha sono dotati di una funzione di gestione dell'alimentazione. Alcuni prodotti consentono di disattivare tale funzione o di estendere il periodo di tempo che trascorre prima che l'alimentazione venga spenta o impostata in standby. In questi casi, il consumo energetico aumenterà. | Italiano |
| Os produtos Yamaha são equipados com uma função de gerenciamento de energia. Alguns produtos permitem desativar essa função ou estender o tempo decorrido antes de se desligar ou entrar em standby. Nesses casos, o consumo de energia aumentará. | Português |
| Τα προϊόντα της Yamaha είναι εξοπλισμένα με μια λειτουργία διαχείρισης ισχύος. Ορισμένα προϊόντα σας δίνουν τη δυνατότητα να απενεργοποιείτε αυτή τη λειτουργία ή να επεκτείνετε το χρονικό διάστημα μέχρι την απενεργοποίηση ή τη θέση σε κατάσταση αναμονής. Σε αυτές τις περιπτώσεις, η κατανάλωση ενέργειας θα αυξηθεί. | Ελληνικά |
| Yamaha-produkterna är utrustade med en energihanteringsfunktion. För vissa produkter kan du inaktivera den funktionen eller för att förlänga tiden som förflutit innan strömmen stängs av eller ställs i vänteläge. I dessa fall ökar energiförbrukningen. | Svenska |
| Yamahas produkter har en strømstyringsfunktion. På nogle produkter er det muligt at deaktivere denne funktion eller at forlænge den tid, der går, før der slukkes for strømmen, eller sættes på standby. I disse tilfælde vil strømforbruget stige. | Dansk |
| Yamaha-tuotteet on varustettu virranhallintatoiminnolla. Joissakin tuotteissa voit poistaa toiminnon käytöstä tai pidentää aikaa, joka kuluu ennen virran katkaisemista tai valmiustilaan asettamista. Näissä tapauksissa energiankulutus kasvaa. | Suomi |
| Produkty Yamaha są wyposażone w funkcję zarządzania energią. Niektóre produkty umożliwiają wyłączenie tej funkcji lub wydłużenie czasu, jaki upływa do wyłączenia zasilania lub przejścia w tryb gotowości. W takich przypadkach zużycie energii wzrośnie. | Polski |
| Produkty Yamaha jsou vybaveny funkcí správy napájení. Některé produkty umožňují tuto funkci zakázat nebo prodloužit dobu, která má uběhnout před vypnutím napájení nebo pohotovostním režimem. V těchto případech se zvýší spotřeba elektřiny. | Čeština |
| A Yamaha termékek energiamedzszment funkcióval vannak ellátva. Egyes termékek lehetővé teszik, hogy letiltsa ezt a funkciót, vagy meghosszabbítsa a kikapcsolás vagy készenléti állapotba helyezés előtt eltelt időt. Ezekben az esetekben az energiafogyasztás növekedni fog. | Magyar |
| Yamaha tooted on varustatud toitehalduse funktsiooniga. Mõned tooted võimaldavad teil selle funktsiooni keelata või pikendada aega, mis möödub enne toite väljalülitamist või ooterežiimi seadmist. Sellistel juhtudel suureneb energiatarbimine. | Eesti |
| Yamaha izstrādājumi ir aprīkoti ar barošanas pārvaldības funkciju. Dažiem izstrādājumiem šo funkciju var atspējot vai paildzināt laiku, kam jāpauz pirms barošanas atslēgšanas vai pāriešanas gaidstāves režīmā. Šādā gadījumā palielināsies enerģijas patēriņš. | Latviešu |
| „Yamaha“ gaminiuose yra energijos sąnaudų valdymo funkcija. Kai kurie gaminiai leidžia išjungti šią funkciją arba pratęsti laiką, praėjusį prieš išjungiant maitinimą arba įjungiant budėjimo režimą. Tokiais atvejais energijos suvartojimas padidės. | Lietuvių |
| Produkty společnosti Yamaha sú vybavené funkciou správy napájania. Niektoré produkty vám umožňujú túto funkciu vypnúť alebo predĺžiť čas, po uplynutí ktorých sa napájanie vypne alebo nastaví do pohotovostného režimu. V takýchto prípadoch sa zvýši spotreba energie. | Slovenčina |
| Yamahini izdelki imajo funkcijo upravljanja z napajanjem. Nekateri izdelki vam omogočajo, da onemogočite to funkcijo ali podaljšate čas, ki mora preteči, preden se napajanje izklopi ali nastavi v stanje pripravljenosti. V teh primerih se bo poraba energije povečala. | Slovenščina |
| Продуктите на Yamaha са снабдени с функция за управление на захранването. Някои продукти ви позволяват да забраните тази функция или да удължите времето, което ще изтече, преди захранването да се изключи или да се настрои в режим на готовност. В тези случаи консумацията на енергия ще се увеличи. | Български |
| Produsele Yamaha sunt echipate cu o funcție de gestionare a energiei. Unele produse vă permit să dezactivați această funcție sau să prelungiți perioada de timp care trece înainte ca alimentarea să fie oprită sau setată în standby. În aceste cazuri, consumul de energie va crește. | Română |
| Yamaha proizvodi opremljeni su funkcijom upravljanja potrošnjom energije. Neki vam proizvodi omogućuju onemogućavanje te funkcije ili produženje vremena koje protekne prije isključivanja napajanja ili postavljanja u stanje pripravnosti. U tim će se slučajevima povećati potrošnja energije. | Hrvatski |
| Yamaha ürünlerinde güç yönetimi işlevi vardır. Bazı ürünler, bu işlevi devre dışı bırakmanıza veya güç kapatılmadan ya da bekleme moduna alınmadan önce geçen süreyi uzatmanıza olanak tanır. Bu gibi durumlarda, enerji tüketimi artacaktır. | Türkçe |

MEMO

LIMITED WARRANTY ON

Music Production Products

Thank you for selecting a YAMAHA product. YAMAHA products are designed and manufactured to provide a high level of defect-free performance. Yamaha Corporation of America ("YAMAHA") is proud of the experience and craftsmanship that goes into each and every YAMAHA product. YAMAHA sells its products through a network of reputable, specially authorized dealers and is pleased to offer you, the Original Owner, the following Limited Warranty, which applies only to products that have been (1) directly purchased from YAMAHA's authorized dealers in the fifty states of the USA and District of Columbia (the "Warranted Area") and (2) used exclusively in the Warranted Area. YAMAHA suggests that you read the Limited Warranty thoroughly, and invites you to contact your authorized YAMAHA dealer or YAMAHA Customer Service if you have any questions.

THIS WARRANTY COVERS THE LISTED PRODUCTS AGAINST DEFECTS IN MATERIALS OR WORKMANSHIP FOR THE FOLLOWING PERIODS:

Warranty Term

| Type of Product | Duration of Warranty from Date of Purchase by or for the Original Owner |
|------------------------------|---|
| SYNTHESIZERS | 1 year |
| MOBILE MINI KEYBOARD | 1 year |
| MONITOR SPEAKERS | 1 year |
| AUDIO INTERFACES | 1 year |
| MIDI CONTROLLERS | 1 year |
| WIND MIDI CONTROLLERS | 1 year |
| MUSIC PRODUCTION ACCESSORIES | 1 year |

Coverage: YAMAHA will, at its option, repair or replace the product covered by this warranty if it becomes defective, malfunctions or otherwise fails to conform with this warranty under normal use and service during the term of this warranty, without charge for labor or materials. Repairs may be performed using new or refurbished parts that meet or exceed YAMAHA specifications for new parts. If YAMAHA elects to replace the product, the replacement may be a reconditioned unit. You will be responsible for any installation or removal charges and for any initial shipping charges if the product(s) must be shipped for warranty service. However, YAMAHA will pay the return shipping charges to any destination within the USA if the repairs are covered by the warranty. This warranty does not cover (a) damage, deterioration or malfunction resulting from accident, negligence, misuse, abuse, improper installation or operation or failure to follow instructions according to the Owner's Manual for this product; any shipment of the product (claims must be presented to the carrier); repair or attempted repair by anyone other than YAMAHA or an authorized YAMAHA Service Center; (b) any unit which has been altered or on which the serial number has been defaced, modified or removed; (c) normal wear, and any periodic maintenance; (d) deterioration due to perspiration, corrosive atmosphere or other external causes such as extremes in temperature or humidity; (e) damages attributable to power line surge or related electrical abnormalities, lightning damage or acts of God; or (f) RFI/EMI (Interference/noise) caused by improper grounding or the improper use of either certified or uncertified equipment, if applicable. Any evidence of alteration, erasing or forgery of

proof-of-purchase documents will cause this warranty to be void. This warranty covers only the Original Owner and is not transferable.

In Order to Obtain Warranty Service: Warranty service will only be provided for defective products within the Warranted Area. Contact your local authorized YAMAHA dealer who will advise you of the procedures to be followed. If this is not successful, contact YAMAHA at the address, telephone number or website shown below. YAMAHA may request that you send the defective product to a local authorized YAMAHA Servicer or authorize return of the defective product to YAMAHA for repair. If you are uncertain as to whether a dealer has been authorized by YAMAHA, please contact YAMAHA's Service Department at the number shown below, or check Yamaha's website at <http://usa.yamaha.com>. Product(s) shipped for service should be packed securely and must be accompanied by a detailed explanation of the problem(s) requiring service, together with the original or a machine reproduction of the bill of sale or other dated, proof-of-purchase document describing the product, as evidence of warranty coverage. Should any product submitted for warranty service be found ineligible therefore, an estimate of repair cost will be furnished and the repair will be accomplished only if requested by you and upon receipt of payment or acceptable arrangement for payment.

Limitation of Implied Warranties and Exclusion of Damages:

ANY IMPLIED WARRANTIES, INCLUDING WARRANTIES OF MERCHANTABILITY AND FITNESS FOR A PARTICULAR PURPOSE SHALL BE LIMITED IN DURATION TO THE APPLICABLE PERIOD OF TIME SET FORTH ABOVE. YAMAHA SHALL NOT BE RESPONSIBLE FOR INCIDENTAL OR CONSEQUENTIAL DAMAGES OR FOR DAMAGES BASED UPON INCONVENIENCE, LOSS OF USE, DAMAGE TO ANY OTHER EQUIPMENT OR OTHER ITEMS AT THE SITE OF USE OR INTERRUPTION OF PERFORMANCES OR ANY CONSEQUENCES. YAMAHA'S LIABILITY FOR ANY DEFECTIVE PRODUCT IS LIMITED TO REPAIR OR REPLACEMENT OF THE PRODUCT, AT YAMAHA'S OPTION. SOME STATES DO NOT ALLOW LIMITATIONS ON HOW LONG AN IMPLIED WARRANTY LASTS OR THE EXCLUSION OR LIMITATION OF INCIDENTAL OR CONSEQUENTIAL DAMAGES, SO THE ABOVE LIMITATION OR EXCLUSION MAY NOT APPLY TO YOU. This Warranty gives you specific legal rights, and you may also have other rights which vary from state to state. This is the only express warranty applicable to the product specified herein; Yamaha neither assumes nor authorizes anyone to assume for it any other express warranty.

If you have any questions about service received or if you need assistance in locating an authorized YAMAHA Servicer, please contact:

Customer Service
Yamaha Corporation of America
6600 Orangethorpe Avenue, Buena Park, CA 90620-1373
Telephone: 800-854-1569 usa.yamaha.com



Do not return any product to the above address without a written
Return Authorization issued by YAMAHA.

Important Notice: Guarantee Information for customers in European Economic Area (EEA) and Switzerland

| | |
|--|-----------------------|
| Important Notice: Guarantee Information for customers in EEA* and Switzerland For detailed guarantee information about this Yamaha product, and Pan-EEA* and Switzerland warranty service, please either visit the website address below (Printable file is available at our website) or contact the Yamaha representative office for your country. * EEA: European Economic Area | English |
| Wichtiger Hinweis: Garantie-Information für Kunden in der EWR* und der Schweiz Für nähere Garantie-Information über dieses Produkt von Yamaha, sowie über den Pan-EWR*- und Schweizer Garantieservice, besuchen Sie bitte entweder die folgend angegebene Internetadresse (eine druckfähige Version befindet sich auch auf unserer Webseite), oder wenden Sie sich an den für Ihr Land zuständigen Yamaha-Vertrieb. *EWR: Europäischer Wirtschaftsraum | Deutsch |
| Remarque importante: informations de garantie pour les clients de l'EEE et la Suisse Pour des informations plus détaillées sur la garantie de ce produit Yamaha et sur le service de garantie applicable dans l'ensemble de l'EEE ainsi qu'en Suisse, consultez notre site Web à l'adresse ci-dessous (le fichier imprimable est disponible sur notre site Web) ou contactez directement Yamaha dans votre pays de résidence. * EEE : Espace Economique Européen | Français |
| Belangrijke mededeling: Garantie-informatie voor klanten in de EER* en Zwitserland Voor gedetailleerde garantie-informatie over dit Yamaha-product en de garantieservice in heel de EER* en Zwitserland, gaat u naar de onderstaande website (u vindt een afdrukbaar bestand op onze website) of neemt u contact op met de vertegenwoordiging van Yamaha in uw land. * EER: Europese Economische Ruimte | Nederlands |
| Aviso importante: información sobre la garantía para los clientes del EEE* y Suiza Para una información detallada sobre este producto Yamaha y sobre el soporte de garantía en la zona EEE* y Suiza, visite la dirección web que se incluye más abajo (la versión del archivo para imprimir esta disponible en nuestro sitio web) o póngase en contacto con el representante de Yamaha en su país. * EEE: Espacio Económico Europeo | Español |
| Avviso importante: informazioni sulla garanzia per i clienti residenti nell'EEA* e in Svizzera Per informazioni dettagliate sulla garanzia relativa a questo prodotto Yamaha e l'assistenza in garanzia nei paesi EEA* e in Svizzera, potete consultare il sito Web all'indirizzo riportato di seguito (è disponibile il file in formato stampabile) oppure contattare l'ufficio di rappresentanza locale della Yamaha. * EEA: Area Economica Europea | Italiano |
| Aviso importante: informações sobre as garantias para clientes da AEE* e da Suíça Para obter uma informação pormenorizada sobre este produto da Yamaha e sobre o serviço de garantia na AEE* e na Suíça, visite o site a seguir (o arquivo para impressão está disponível no nosso site) ou entre em contato com o escritório de representação da Yamaha no seu país. * AEE: Área Económica Europeia | Português |
| Σημαντική σημείωση: Πληροφορίες εγγύησης για τους πελάτες στον ΕΟΧ* και Ελλάδα Για λεπτομερείς πληροφορίες εγγύησης σχετικά με το παρόν προϊόν της Yamaha και την κάλυψη εγγύησης σε όλες τις χώρες του ΕΟΧ και την Ελλάδα, επισκεφτείτε την παρακάτω ιστοσελίδα (Εκτυπώσιμη μορφή είναι διαθέσιμη στην ιστοσελίδα μας) ή απευθυνθείτε στην αντιπροσωπεία της Yamaha στη χώρα σας. * ΕΟΧ: Ευρωπαϊκός Οικονομικός Χώρος | Ελληνικά |
| Viktigt: Garantiinformation för kunder i EES-området* och Schweiz För detaljerad information om denna Yamahaprodukt samt garantiservice i hela EES-området* och Schweiz kan du antingen besöka nedanstående webbadress (en utskriftsvänlig fil finns på webbplatsen) eller kontakta Yamahas officiella representant i ditt land. * EES: Europeiska Ekonomiska Samarbetsområdet | Svenska |
| Viktig merknad: Garantiinformasjon for kunder i EØS* og Sveits Detaljert garantiinformasjon om dette Yamaha-produktet og garantiservice for hele EØS-området* og Sveits kan fås enten ved å besøke nettstedene nedenfor (utskriftsversjon finnes på våre nettsider) eller kontakte Yamahas kontoret i landet der du bor. *EØS: Det europeiske økonomiske samarbeidsområdet | Norsk |
| Vigtig oplysning: Garantioplysninger til kunder i EØO* og Schweiz De kan finde detaljerede garantioplysninger om dette Yamaha-produkt og den fælles garantiserviceordning for EØO* (og Schweiz) ved at besøge det websted, der er angivet nedenfor (der findes en fil, som kan udskrives, på vores websted), eller ved at kontakte Yamahas nationale repræsentationskontor i det land, hvor De bor. * EØO: Det Europæiske Økonomiske Område | Dansk |
| Tärkeä ilmoitus: Takuutiedot Euroopan talousalueen (ETA)* ja Sveitsin asiakkaille Tämän Yamaha-tuotteen sekä ETA-alueen ja Sveitsin takuuta koskevat yksityiskohtaiset tiedot saatte alla olevasta nettiosoitteesta. (Tulostettava tiedosto saatavissa sivustollamme.) Voitte myös ottaa yhteyttä paikalliseen Yamaha-edustajaan. *ETA: Euroopan talousalue | Suomi |
| Ważne: Warunki gwarancyjne obowiązujące w EOG* i Szwajcarii Aby dowiedzieć się więcej na temat warunków gwarancyjnych tego produktu firmy Yamaha i serwisu gwarancyjnego w całym EOG* i Szwajcarii, należy odwiedzić wskazaną poniżej stronę internetową (Plik gotowy do wydruku znajduje się na naszej stronie internetowej) lub skontaktować się z przedstawicielstwem firmy Yamaha w swoim kraju. * EOG — Europejski Obszar Gospodarczy | Polski |
| Důležité oznámení: Záruční informace pro zákazníky v EHS* a ve Švýcarsku Podrobné záruční informace o tomto produktu Yamaha a záručním servisu v celém EHS* a ve Švýcarsku naleznete na níže uvedené webové adrese (soubor k tisku je dostupný na našich webových stránkách) nebo se můžete obrátit na zastoupení firmy Yamaha ve své zemi. * EHS: Evropský hospodářský prostor | Česky |
| Fontos figyelemzetetés: Garancia-információk az EGT* területén és Svájcban élő vásárlók számára A jelen Yamaha termékre vonatkozó részletes garancia-információk, valamint az EGT*-re és Svájcra kiterjedő garanciális szolgáltatás tekintetében keresse fel webhelyünket az alábbi címen (a webhelyen nyomtatható fájl is talál), vagy pedig lépjen kapcsolatba az országában működő Yamaha képviselői irodával. * EGT: Európai Gazdasági Térség | Magyar |
| Oluline märkus: Garantiiteave Euroopa Majanduspiirkonna (EMP)* ja Šveitsi klientidele Täpsema teabe saamiseks selle Yamaha selle Yamaha toote garantii ning kogu Euroopa Majanduspiirkonna ja Šveitsi garantiiteeninduse kohta, külastage palun veebisaiti alljärgneval aadressil (meie saidil on saadaval prinditav fail) või pöörduge Teie regiooni Yamaha esinduse poole. * EMP: Euroopa Majanduspiirkond | Eesti keel |
| Svarīgs paziņojums: garantijas informācija klientiem EEZ* un Šveicē Lai saņemtu detalizētu garantijas informāciju par šo Yamaha produktu, kā arī garantijas apkalpošanu EEZ* un Šveicē, lūdzu, apmeklējiet zemāk norādīto tīmekļa vietnes adresi (tīmekļa vietnē ir pieejams drukājams fails) vai sazinieties ar jūsu valsti apkalpojošo Yamaha pārstāvniecību. * EEZ: Eiropas Ekonomikas zona | Latviešu |
| Dėmesio: informacija dėl garantijos pirkėjams EEE* ir Šveicarijoje Jei reikia išsamios informacijos apie šį „Yamaha“ produktą ir jo techninę priežiūrą visoje EEE* ir Šveicarijoje, apsilankykite mūsų svetainėje toliau nurodytu adresu (svetainėje yra spausdintas failas) arba kreipkitės į „Yamaha“ atstovybę savo šaliai. *EEE – Europos ekonominė erdvė | Lietuvių kalba |
| Dôležité upozornenie: Informácie o záruke pre zákazníkov v EHP* a Švajčiarsku Podrobné informácie o záruke týkajúce sa tohto produktu od spoločnosti Yamaha a garančnom servise v EHP* a Švajčiarsku nájdete na webovej stránke uvedenej nižšie (na našej webovej stránke je k dispozícii súbor na tlač) alebo sa obráťte na zástupcu spoločnosti Yamaha vo svojej krajine. * EHP: Európsky hospodársky priestor | Slovenčina |
| Pomembno obvestilo: Informacije o garanciji za kupce v EGP* in Švici Za podrobnejše informacije o tem Yamahinem izdelku ter garancijskem servisu v celotnem EGP in Švici, obiščite spletno mesto, ki je navedeno spodaj (natisljiva datoteka je na voljo na našem spletnem mestu), ali se obrnite na Yamahinega predstavnika v svoji državi. * EGP: Evropski gospodarski prostor | Slovenščina |
| Важно съобщение: Информация за гаранцията за клиенти в ЕИП* и Швейцария За подробна информация за гаранцията за този продукт на Yamaha и гаранционното обслужване в паневропейската зона на ЕИП* и Швейцария или посетете посочения по-долу уеб сайт (на нашия уеб сайт има файл за печат), или се свържете с представителния офис на Yamaha във вашата страна. * ЕИП: Европейско икономическо пространство | Български език |
| Notificare importantă: Informații despre garanție pentru clienții din SEE* și Elveția Pentru informații detaliate privind acest produs Yamaha și serviciul de garanție Pan-SEE* și Elveția, vizitați site-ul la adresa de mai jos (fișierul imprimabil este disponibil pe site-ul nostru) sau contactați biroul reprezentanței Yamaha din țara dumneavoastră. * SEE: Spațiul Economic European | Limba română |
| Važna obavijest: Informacije o jamstvu za države EGP-a i Švicarske Za detaljne informacije o jamstvu za ovaj Yamahin proizvod te jamstvenom servisu za cijeli EGP i Švicarsku, molimo Vas da posjetite web-stranicu navedenu u nastavku ili kontaktirate ovlaštenog Yamahinog dobavljača u svojoj zemlji. * EGP: Evropski gospodarski prostor | Hrvatski |

<https://europe.yamaha.com/warranty/>

Yamaha Worldwide Representative Offices

English

For details on the product(s), contact your nearest Yamaha representative or the authorized distributor, found by accessing the 2D barcode below.

Deutsch

Wenden Sie sich für nähere Informationen zu Produkten an eine Yamaha-Vertretung oder einen autorisierten Händler in Ihrer Nähe. Diese finden Sie mithilfe des unten abgebildeten 2D-Strichcodes.

Français

Pour obtenir des informations sur le ou les produits, contactez votre représentant ou revendeur agréé Yamaha le plus proche. Vous le trouverez à l'aide du code-barres 2D ci-dessous.

Español

Para ver información detallada sobre el producto, contacte con su representante o distribuidor autorizado Yamaha más cercano. Lo encontrará escaneando el siguiente código de barras 2D.

Português

Para mais informações sobre o(s) produto(s), fale com seu representante da Yamaha mais próximo ou com o distribuidor autorizado acessando o código de barras 2D abaixo.

Italiano

Per dettagli sui prodotti, contattare il rappresentante Yamaha o il distributore autorizzato più vicino, che è possibile trovare tramite il codice a barre 2D in basso.

Nederlands

Neem voor meer informatie over de producten contact op met uw dichtstbijzijnde Yamaha-vertegenwoordiger of de geautoriseerde distributeur, te vinden via de onderstaande 2D-barcode.

Polski

Aby uzyskać szczegółowe informacje na temat produktów, skontaktuj się z najbliższym przedstawicielem firmy Yamaha lub autoryzowanym dystrybutorem, którego znajdziesz za pośrednictwem poniższego kodu kreskowego 2D.

Русский

Чтобы узнать подробнее о продукте (продуктах), свяжитесь с ближайшим представителем или авторизованным дистрибьютором Yamaha, воспользовавшись двухмерным штрихкодом ниже.

Dansk

Hvis du vil have detaljer om produktet/produkterne, kan du kontakte den nærmeste Yamaha-repræsentant eller autoriserede Yamaha-distributør, som du finder ved at scanne 2D-stregkode nedenfor.

Svenska

Om du vill ha mer information om produkterna kan du kontakta närmaste Yamaha-representant eller auktoriserade distributör med hjälp av 2D-streckkoden nedan.



https://manual.yamaha.com/dmi/address_list/

Čeština

Podrobnosti o produktu(ech) získáte od nejbližšího zástupce společnosti Yamaha nebo autorizovaného distributora, který byl nalezen při použití 2D čárového kódu níže.

Slovenčina

Podrobné informácie o produkte(-och) vám poskytne najbližší zástupca spoločnosti Yamaha alebo autorizovaný distribútor, ktorého nájdete pomocou nižšie uvedeného 2D čiarového kódu.

Magyar

A termék(ek)re vonatkozó részletekért forduljon a legközelebbi Yamaha képviselőhöz vagy a hivatalos forgalmazóhoz, amelyet az alábbi 2D vonalkód segítségével találhat meg.

Slovenščina

Če želite podrobnejše informacije o izdelkih, se obrnite na najbližjega Yamahinega predstavnika ali pooblaščenega distributerja, ki ga najdete prek 2D-kode v nadaljevanju.

Български

За подробности относно продукта/ите се свържете с най-близкия представител на Yamaha или оторизиран дистрибутор, който можете да откриете, като използвате 2D баркода по-долу.

Română

Pentru detalii privind produsele, contactați cel mai apropiat reprezentant Yamaha sau distribuitorul autorizat, pe care îl puteți găsi accesând codul de bare 2D de mai jos.

Latviešu

Lai iegūtu plašāku informāciju par izstrādājumiem, sazinieties ar tuvāko Yamaha pārstāvi vai pilnvaroto izplatītāju, kuru atradīsiet, izmantojot tālāk pieejamo 2D svītrkodu.

Lietuvių

Norėdami gauti daugiau informacijos apie gaminį (-ius), kreipkitės į artimiausią „Yamaha“ atstovą arba įgaliotąjį platintoją, kurį rasite nuskaityę toliau pateiktą 2D brūkšninį kodą.

Eesti

Toodete kohta täpsema teabe saamiseks võtke ühendust lähima Yamaha esindaja või autoriseeritud levitajaga, kelle leiате allpool asuva 2D-võõtkoodi kaudu.

Hrvatski

Za detalje o proizvodima obratite se lokalnom predstavku ili ovlaštenom distributeru tvrtke Yamaha, kojeg možete pronaći skeniranjem 2D crtičnog koda u nastavku.

Türkçe

Ürünler hakkında ayrıntılar için, aşağıdaki 2D kodlu motora erişerek bulunan size en yakın Yamaha temsilcisine veya yetkili bayiye başvurun.

MEMO

MEMO

Yamaha Global Site
<https://www.yamaha.com/>
Yamaha Downloads
<https://download.yamaha.com/>

© 2012 Yamaha Corporation
Published 12/2024
KSTY-F0



ZV90250