

CENTER

YAMAHA

KX-W382

KX-W282

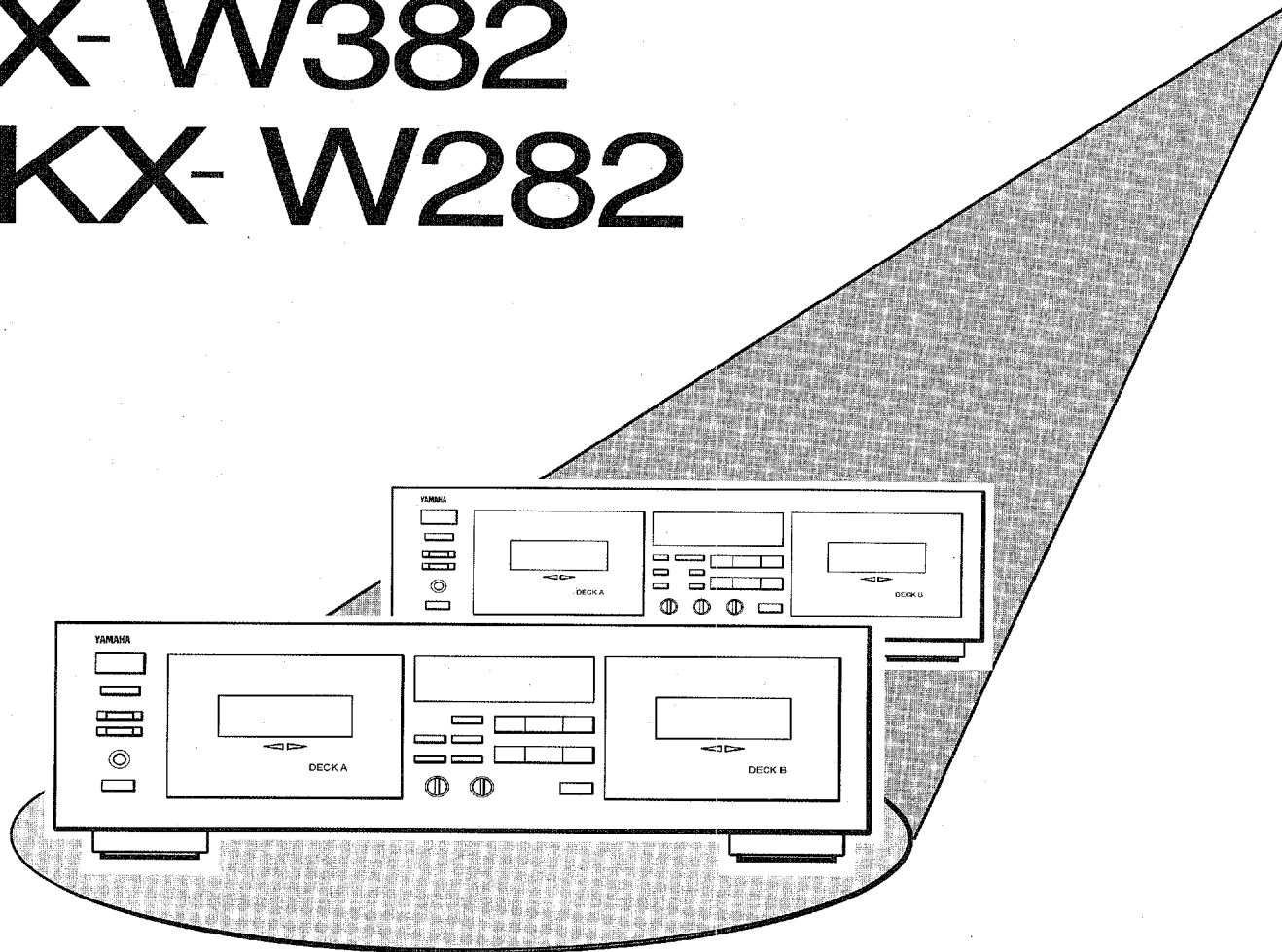

Natural Sound Stereo Cassette Deck

OWNER'S MANUAL



IMPORTANT

Please record the serial number of your unit in the space below.

Model:

Serial No:

The serial number is located on the rear of the unit.
Retain this Owner's Manual in a safe place for future reference.

Thank you for purchasing the YAMAHA stereo cassette deck.

SAFETY INSTRUCTIONS

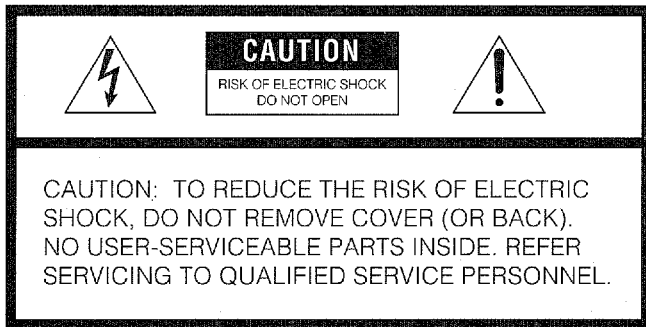

• Explanation of Graphical Symbols



The lightning flash with arrowhead symbol, within an equilateral triangle, is intended to alert you to the presence of uninsulated "dangerous voltage" within the product's enclosure that may be of sufficient magnitude to constitute a risk of electric shock to persons.

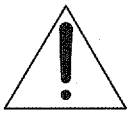

The exclamation point within an equilateral triangle is intended to alert you to the presence of important operating and maintenance (servicing) instructions in the literature accompanying the appliance.

WARNING

To reduce the risk of fire or electric shock, do not expose this appliance to rain or moisture.

- 1** Read Instructions — All the safety and operating instructions should be read before the appliance is operated.
- 2** Retain Instructions — The safety and operating instructions should be retained for future reference.
- 3** Heed Warnings — All warnings on the appliance and in the operating instructions should be adhered to.
- 4** Follow Instructions — All operating and other instructions should be followed.
- 5** Water and Moisture — The appliance should not be used near water — for example, near a bathtub, washbowl, kitchen sink, laundry tub, in a wet basement, or near swimming pool, etc.
- 6** Carts and Stands — The appliance should be used only with a cart or stand that is recommended by the manufacturer.

6A An appliance and cart combination should be moved with care. Quick stops, excessive force, and uneven surfaces may cause the appliance and cart combination to overturn.



7 Wall or Ceiling Mounting — The appliance should be mounted to a wall or ceiling only as recommended by the manufacturer.

8 Ventilation — The appliance should be situated so that its location or position does not interfere with its proper ventilation. For example, the appliance should not be situated on a bed, sofa, rug or similar surfaces that may block the ventilation openings; or placed in a built-in installation, such as a bookcase or cabinet that may impede the flow of air through the ventilation openings.

9 Heat — The appliance should be situated away from heat sources such as radiators, stoves, or other appliances that produce heat.

10 Power Sources — The appliance should be connected to a power supply only of the type described in the operating instructions or as marked on the appliance.

11 Power-Cord Protection — Power-supply cords should be routed so that they are not likely to be walked on or pinched by items placed upon or against them, paying attention to receptacles, and the point where they exit from the appliance.

12 Cleaning — The appliance should be cleaned only as recommended by the manufacturer.

13 No Use Periods — The power cord of the appliance should be unplugged from the outlet when left unused for a long period of time.

14 Object and Liquid Entry — Care should be taken so that objects do not fall into and liquids not spilled into the inside of the appliance.

15 Damage Requiring Service — The appliance should be serviced by qualified service personnel when:

- A.** The power-supply cord or the plug has been damaged; or
- B.** Objects have fallen, or liquid has been spilled into the appliance; or
- C.** The appliance has been exposed to rain; or
- D.** The appliance does not appear to operate normally or exhibits a marked change in performance; or
- E.** The appliance has been dropped, or the cabinet damaged.

16 Servicing — The user should not attempt to service the appliance beyond those means described in the operating instructions. All other servicing should be referred to qualified service personnel.

17 Grounding or Polarization — The precautions should be taken so that the grounding or polarization of an appliance is not defeated.

CAUTION: READ THIS BEFORE OPERATING YOUR UNIT.

FCC INFORMATION (U.S.A.)

1. IMPORTANT NOTICE: DO NOT MODIFY THIS UNIT!

This product, when installed as indicated in the instructions contained in this manual, meets FCC requirements. Modifications not expressly approved by Yamaha may void your authority, granted by the FCC, to use the product.

2. IMPORTANT: When connecting this product to accessories and/or another product use only high quality shielded cables. Cables supplied with this product **MUST** be used. Follow all installation instructions. Failure to follow instructions could void your FCC authorization to use this product in the USA.

3. NOTE: This product has been tested and found to comply with the requirements listed in FCC Regulations, Part 15 for Class "A" digital devices. Compliance with these requirements provides a reasonable level of assurance that your use of this product, in a commercial environment, will not result in harmful interference with other electronic devices. However, operation of this product in a residential area is likely to cause interference in some form. In this case you, the user, bear the responsibility of correcting this condition.

This product generates/uses radio frequencies and, if not installed and used according to the instructions found in the users manual, may cause interference harmful to the operation of other electronic devices. Compliance with FCC regulations does not guarantee that interference will not occur in all installations. If this product is found to be the source of interference, which can be determined by turning the product "OFF" and "ON", please try to eliminate the problem using one of the following measures:

Relocate either the product generating the interference or the device that is being affected by the interference.

Utilize power outlets that are on different branch (circuit breaker or fuse) circuits or install AC line filter/s.

In the case of radio or TV interference, relocate/reorient the antenna. If the antenna lead-in is 300 ohm ribbon lead, change the lead-in to coaxial type cable.

If these corrective measures do not produce satisfactory results, please contact your local retailer that is authorized to distribute this type of product. If you cannot locate the appropriate retailer, please contact Yamaha Electronics Corp., U.S.A. 6600 Orangethorpe Ave, Buena Park, CA90620

The above statements apply **ONLY** to those products distributed by Yamaha Corporation of America or its subsidiaries.

We Want You Listening For A Lifetime

YAMAHA and the Electronic Industries Association's Consumer Electronics Group want you to get the most out of your equipment by playing it at a safe level. One that lets the sound come through loud and clear without annoying blaring or distortion – and, most importantly, without affecting your sensitive hearing. Since hearing damage from loud sounds is often undetectable until it is too late, YAMAHA and the Electronic Industries Association's Consumer Electronics Group recommend you avoid prolonged exposure to excessive volume levels.



1. This unit is a sophisticated stereo cassette deck. To ensure proper operation for the best possible performance, please read this manual carefully.
2. Choose the installation location of your unit carefully. Avoid placing it in direct sunlight or close to source of heat. Also avoid locations subject to vibration and excessive dust, heat, cold or moisture. Keep it away from sources of hum such as transformers or motors.
3. Do not open the cabinet as this may result in damage to the deck or electrical shock. If a foreign object should get into the deck, contact your local dealer.
4. Do not apply excessive force when operating switches and knobs.
5. When moving the deck, be sure to first pull out the power plug and remove all cords connecting the deck to other equipment.
6. Do not attempt to clean this unit with chemical solvents as this may damage the finish. Use a clean, dry cloth.
7. Never allow metallic items (e.g. screwdrivers, tools, etc.) to come near the record/playback head assembly. Doing so may not only scratch or damage the head's mirror-smooth finish, it may also change the magnetic characteristics of the heads, causing a deterioration in reproduction quality.
8. Although the record/playback head used in this unit is a high quality head with outstanding reproduction characteristics, it can become dirty through the use of old tapes or from dust accumulation over time. This can have a serious effect on reproduction quality. Clean the heads regularly with one of the commonly available head cleaners or with cleaning solutions as explained later in this manual.
9. Be sure to read the "Troubleshooting" section of this manual for advice on common operating errors before concluding that your unit is faulty.
10. Unplug the power cord from the wall outlet if the unit is not to be used for an extended period of time. To disconnect the cord, pull it out by grasping the plug. Never pull the cord itself.
11. Keep this manual in a safe place for future reference.
12. **Voltage Selector (General model only)**
The voltage selector on the rear panel of this unit must be set for your local mains voltage BEFORE plugging in the AC mains supply.

Please check the copyright laws in your country to record from records, compact discs, radio, etc. Recording of copyright material may infringe copyright laws.

TABLE OF CONTENTS

FEATURES	4	DUBBING	12
CONNECTIONS	4	CASSETTE TAPES	13
PLAYBACK	5	MAINTENANCE	14
Basic operation	5	OPTIONAL REMOTE CONTROL TRANSMITTER	14
SELECTION SEARCH	7	TROUBLESHOOTING	15
RELAY PLAYBACK	8	SPECIFICATIONS	Back cover
PLAY TRIM control adjustment	8		
RECORDING	9		
Basic operation	9		
REC MUTE operation	11		
REC RETURN operation	11		

FEATURES

- High Quality Hard Permalloy Recording/Playback Head in Deck A and Playback Head in Deck B
- Dolby HX Pro Dynamic Bias Servo (KX-W382 only)
- Dolby B/C Noise Reduction
- Play Trim Control for improved playback compatibility with other decks (KX-W382 only)
- Auto Tape Selector
- Relay Playback from DECK A to DECK B
- Selection Search
- Recording Mute Function
- Rec Return Operation
- Easy Dubbing Operation at Selectable Speed (Normal/High)
- Peak Level Meters with Peak Hold Function (KX-W382 only)
- Remote Control Capability with Optional Remote Control Transmitter

CONNECTIONS

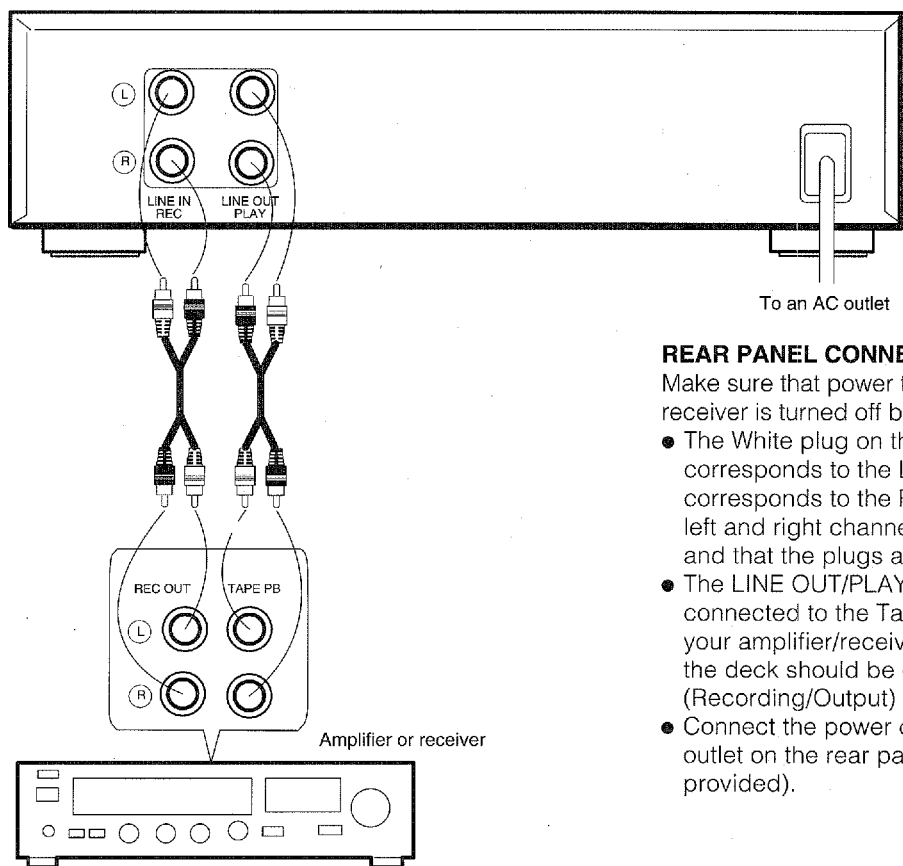

REAR PANEL CONNECTIONS

Make sure that power to both the deck and your amplifier/receiver is turned off before making any connections.

- The White plug on the paired connecting cables corresponds to the Left channel and the Red plug corresponds to the Right channel. Make sure that the left and right channel connections are properly made, and that the plugs are inserted firmly.
- The LINE OUT/PLAY jacks on the deck should be connected to the Tape PB (Playback/Input) jacks on your amplifier/receiver, and the LINE IN/REC jacks on the deck should be connected to the Rec Out (Recording/Output) jacks on your amplifier/receiver.
- Connect the power cord to an AC wall outlet or to an AC outlet on the rear panel of your amplifier/receiver (if provided).

PLAYBACK (Common to DECKS A and B)

Preparation for playback

- Turn on the POWER switch.
- Set your amplifier or receiver to cassette deck function mode.

Basic operation - To play back a cassette tape

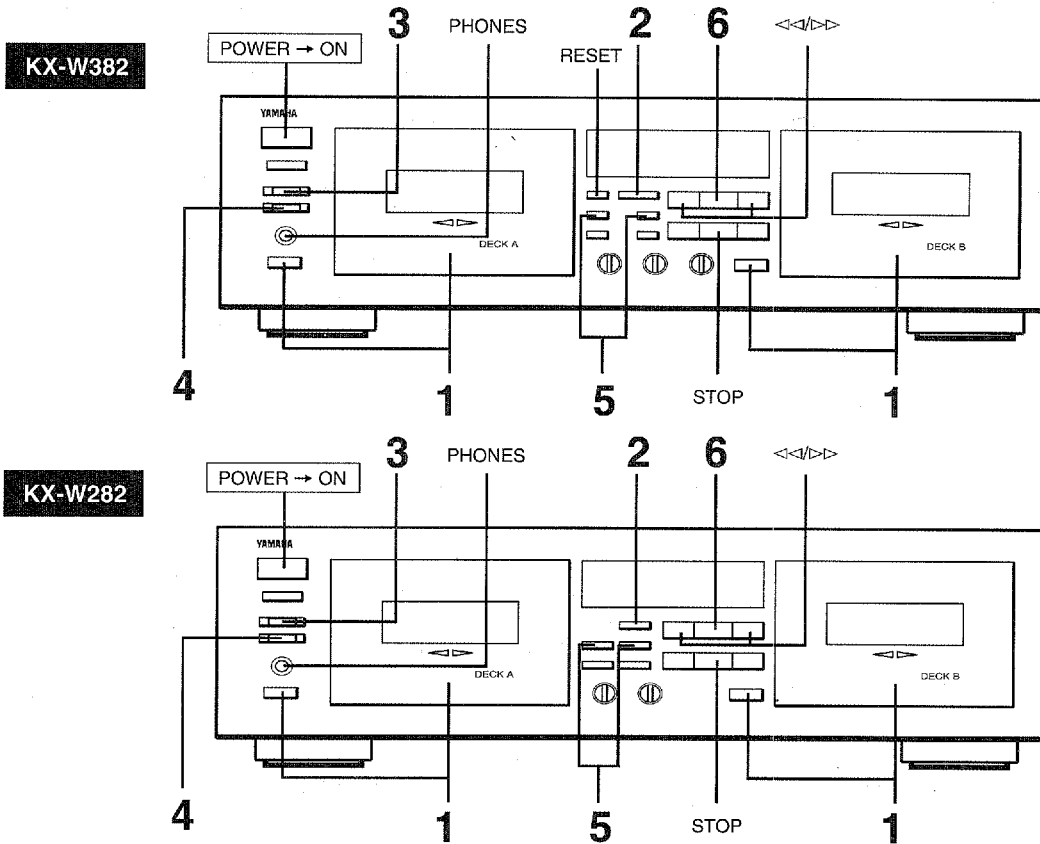

<p>1</p> <p>Insert the cassette with the exposed tape side facing down. (The side facing you is called the forward side and the opposite side is called the reverse side.) To close the compartment, push in the compartment door until it locks shut.</p>	<p>2</p> <p>Press the DECK A/B button to select the deck to be operated. The corresponding indicator lights on the display.</p>	<p>3</p> <p>Refer to the following description.</p>	<p>4</p> <p>Refer to the following description.</p>	<p>5</p> <p>Select the tape running direction for DECK A or B. Each time this button is pressed, the tape running direction changes between forward (>) and reverse (<), and the corresponding indicator lights on the display.</p>	<p>6</p>
---	--	--	--	--	-----------------

To fast forward or rewind the tape

When the tape running indicator > is lit:

Pressing the >> button fast forwards the tape while pressing the <<< button rewinds the tape.

When the tape running indicator < is lit:

Pressing the <<< button fast forwards the tape while pressing the >>> button rewinds the tape.

To stop playback

Press the STOP button. To remove the cassette tape, press the EJECT button. The cassette compartment door opens. To turn off the power, press the POWER button.

DOLBY NR selector setting (in step 3)

Be sure to set the DOLBY NR selector according to the system used for recording.



OFF: For a tape recorded with DOLBY NR OFF.

B: For a tape recorded with DOLBY B NR.



C: For a tape recorded with DOLBY C NR.

* Dolby noise reduction manufactured under license from Dolby Laboratories Licensing Corporation. "DOLBY" and the double-D symbol  are trademarks of Dolby Laboratories Licensing Corporation.

REVERSE MODE selector setting (in step 4)

The auto reverse function allows the tape running direction to be reversed automatically. Select an auto reverse mode ( or ) or manual reverse mode (.

: When playback or fast forwarding (or rewinding) of one side of a tape is finished, the deck stops at the end of the tape.

: Both sides of the tape are played back. After playing, the deck stops at the end of the tape. (When the tape running direction is set to , only the reverse side is played.)

- When the tape is fast forwarded to the end of the forward side, playback automatically starts from the reverse side.

: Both sides of the tape are repeatedly played back (up to 8 times).

- When the tape is fast forwarded to the end of a side, playback automatically starts from the other side. When the tape is rewound to the beginning of a side, playback automatically starts from the beginning.

Display during playback

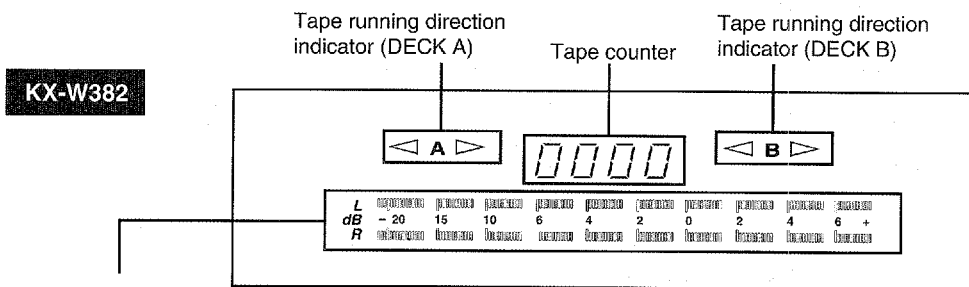

Peak level meters

Indicate the peaks of the signal levels during recording and playback over a -20 dB to +6 dB range. There are separate meters for each left and right channel. These level meters have a peak hold function which holds the peak level for about 1.5 seconds.

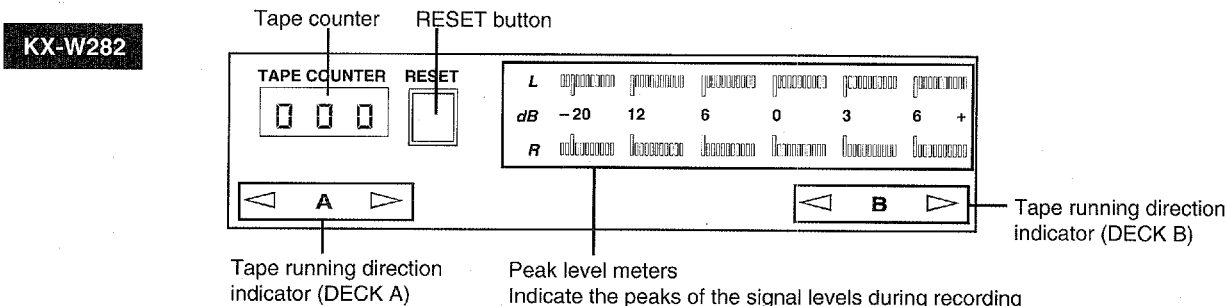

Tape running direction indicator (DECK A)

Peak level meters

Indicate the peaks of the signal levels during recording and playback over a -20 dB to +6 dB range. There are separate meters for each left and right channel.

Tape running direction indicator (DECK B)

To adjust the volume level

Use the volume control of the amplifier or receiver.

To use headphones

Insert the headphones plug into the PHONES jack. Since the sound is also heard from the speakers, operate the amplifier to cut off the sound from the speakers for private listening.

Notes

- When loading the cassette tapes into both DECKs A and B, the relay playback automatically functions (refer to page 8). Therefore, to play back only a cassette tape in either DECK A or B, remove a cassette tape from the other cassette compartment.
- Never press the EJECT button during playback.

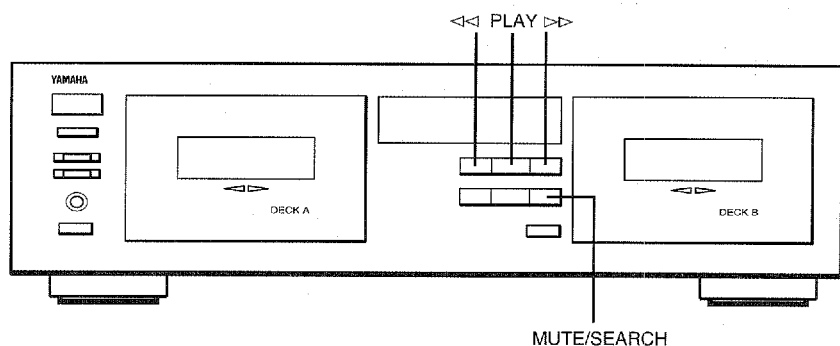

SELECTION SEARCH - To play back a desired selection by searching for the beginning of the selection

To search for the next selection

When the > tape running indicator is lit:

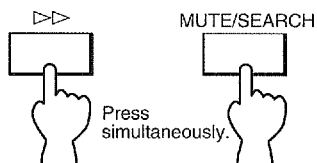

When the < tape running indicator is lit:

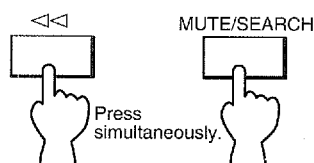

To search for the beginning of the current selection

When the > tape running indicator is lit:

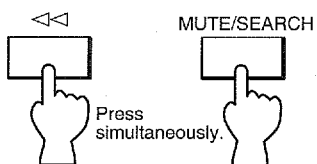

When the < tape running indicator is lit:

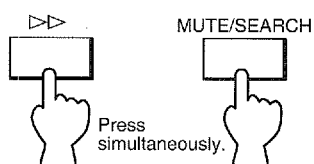

To search for the selection located before the current selection

● Operate the following buttons when the beginning of the current selection is being played.

When the > tape running indicator is lit:

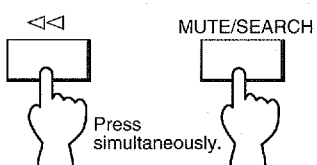

When the < tape running indicator is lit:

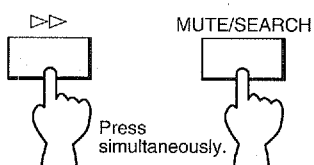

Notes

- The blank interval between selections must be at least 4 seconds long.
- Selection search may not operate properly with tapes recorded at a low recording level or which have excessive noise.
- Use the tape counter to aid in locating a point on a tape (0000 to 9999 (000 to 999 for KX-W282)). To set the counter reading to "0000" ("000" for KX-W282), press the RESET button.

RELAY PLAYBACK - To play DECK A and DECK B sequentially

Load the cassette tapes into DECKS A and B, start playback of DECK A.
The relay patterns are different according to the REVERSE MODE selector. Refer to the followings.

When the REVERSE MODE button is set to \rightleftarrows :

DECK A (forward side or reverse side) \Rightarrow DECK B (forward side or reverse side)

When the REVERSE MODE button is set to \rightarrow :

DECK A (forward side \Rightarrow reverse side) \Rightarrow DECK B (forward side \Rightarrow reverse side)

● When the tape running direction is set to \leftarrow , only the reverse side is played.

When the REVERSE MODE button is set to \leftrightarrow :

DECK A (forward side \Rightarrow reverse side) \Rightarrow DECK B (forward side \Rightarrow reverse side)

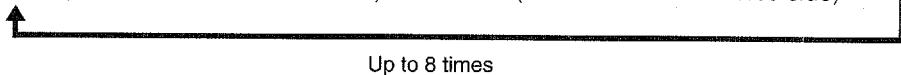

PLAY TRIM control adjustment (KX-W382 only)

When the level of high frequencies is too boosted or absent while playing a tape recorded on another cassette deck, adjust the high frequency response with the PLAY TRIM control.

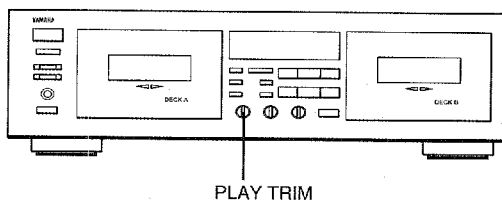

When high frequencies are too boosted, attenuate the high frequencies.

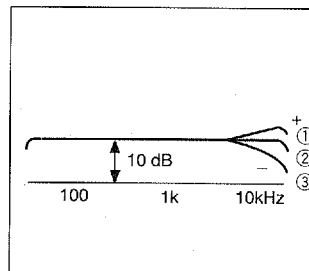
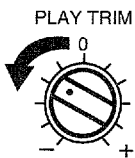

When high frequencies are absent, boost the high frequencies.

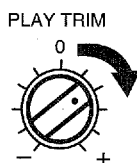

- ① High frequency sound is too boosted.
- ② Flat
- ③ High-frequency sound is absent.

RECORDING (On DECK A only)

Preparation for recording

- Turn on the POWER switch.
- Recording can be performed only on DECK A, so be sure to load a blank cassette tape in DECK A.

Basic operation - To record a program source onto DECK A

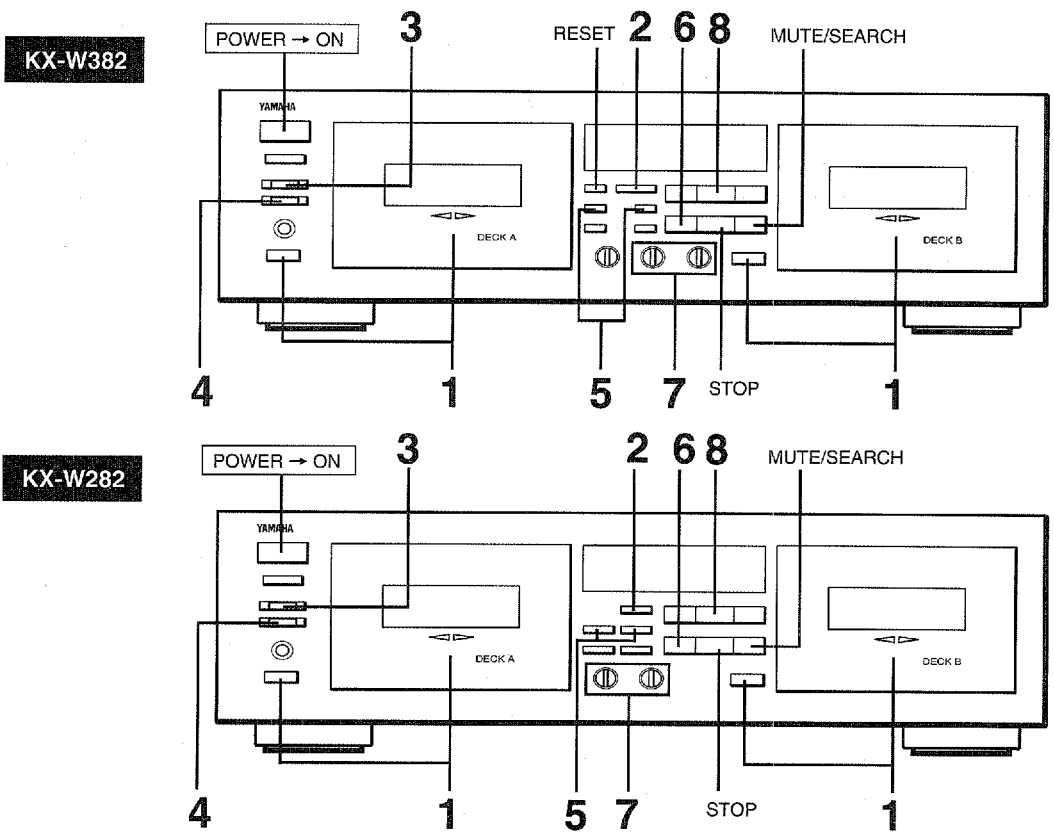

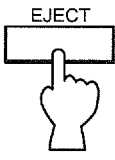
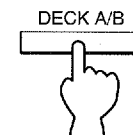
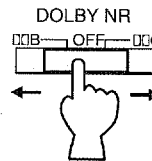
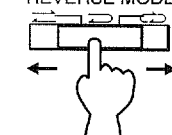
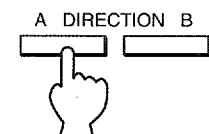
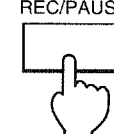
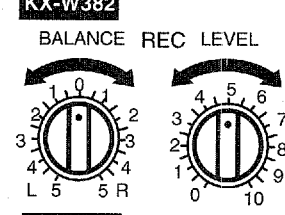
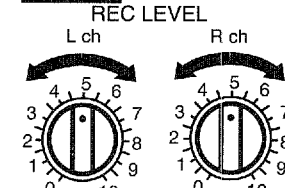
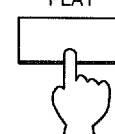
<p>1</p>  <p>Insert the cassette with the exposed tape side facing down. (The side facing you is called the forward side and the opposite side is called the reverse side.) To close the compartment, push in the compartment door until it locks shut.</p>	<p>2</p>  <p>Press the DECK A/B button to select DECK A. The A indicator lights on the display.</p>	<p>3</p>  <p>Refer to the following description.</p>	<p>4</p>  <p>Refer to the following description.</p>
<p>5</p>  <p>Select the tape running direction for DECK A. Each time this button is pressed, the tape running direction changes between forward (>) and reverse (<), and the corresponding indicator lights on the display.</p>	<p>6</p>  <p>The REC indicator lights on the display. The deck enters the rec pause mode.</p>	<p>7</p> <div style="display: flex; justify-content: space-around;"> <div style="text-align: center;"> <p>KX-W382</p>  </div> <div style="text-align: center;"> <p>KX-W282</p>  </div> </div> <p>Play the program source to be recorded and adjust the recording level and balance.</p>	
<p>8</p>  <p>Recording starts.</p>			

DOLBY NR selector setting (in step 3)

Set the DOLBY NR selector according to your purpose.

OFF: No noise reduction.

B: For recording the sources with Dolby B NR.

C: For recording the sources with Dolby C NR.

- Dolby noise reduction is an extremely effective method of reducing undesirable background hiss on tapes. This unit incorporates both Dolby B NR and the newer Dolby C NR system. Dolby C NR is approximately twice as effective as the earlier Dolby B NR.

REVERSE MODE selector setting (in step 4)

The auto reverse function allows the tape running direction to be reversed automatically. Select an auto reverse mode (↔ or ⇄) or manual reverse mode (⇄).

⇄: When recording on one side of a tape is finished, the deck stops at the end of the tape.

↔ or ⇄: Both sides of a tape are recorded. After recording, the deck stops at the end of the tape.

- When the tape running direction is set to ◀, only the reverse side is recorded.

Setting the recording level (in step 7)

Play the loudest passage of the source to be recorded and watch the meter readings.

KX-382

Adjust the REC LEVEL control so that the highest peak reaches +4 of the optimum recording level. Normally, it is best to adjust the BALANCE control such that the left and right meter readings are even.

KX-282

Adjust the REC LEVEL controls so that the highest peak reaches +3 of the optimum recording level. Normally, it is best to adjust the REC LEVEL controls such that the left and right meter readings are even.

Display during recording

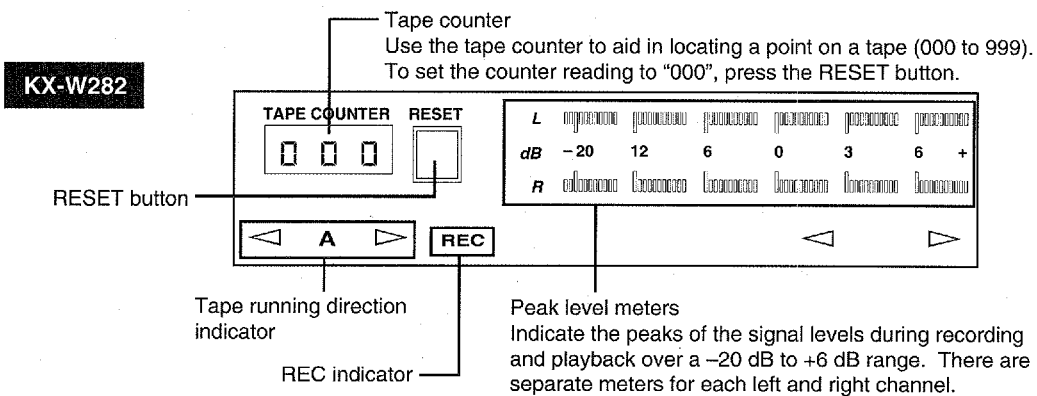
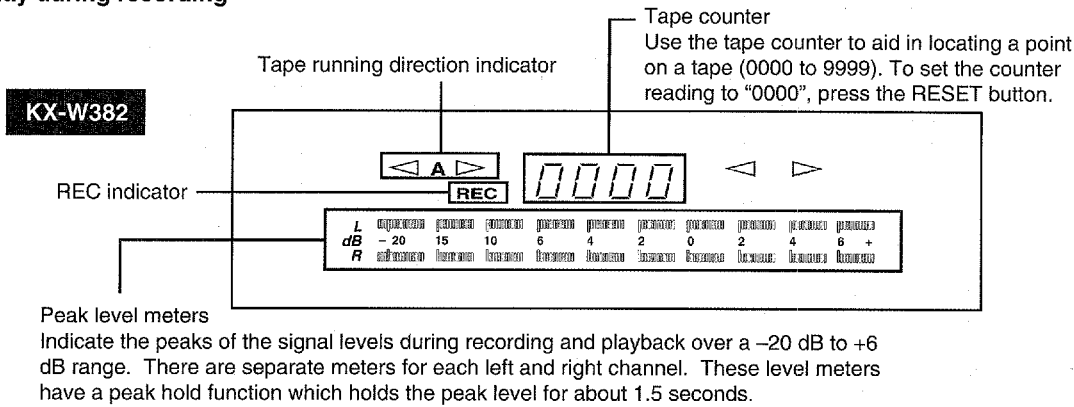

To stop recording:

Press the STOP button.

To stop recording temporarily:

Press the REC/PAUSE button. To resume recording, press the PLAY button.

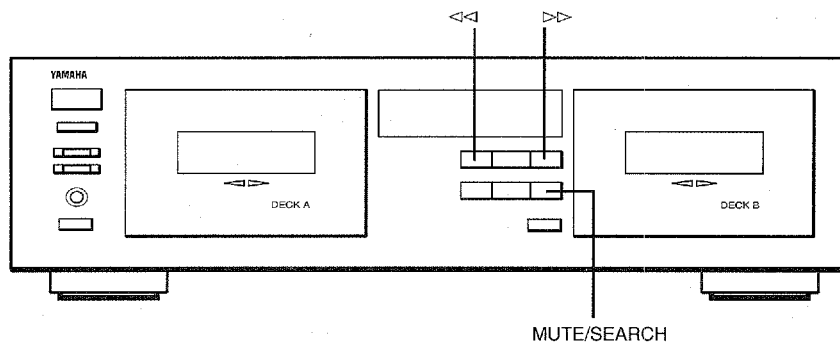

REC MUTE operation - inserting a blank space during recording

During recording:



During Rec mute operation, the REC indicator blinks.

A 4-second blank interval is automatically recorded on the tape and then the deck enters Rec pause mode. If a blank interval longer than 4 seconds is desired, keep pressing for as long as you want. When the MUTE/SEARCH button is released, the deck enters Rec pause mode after making a 4-second blank interval. To resume recording, press the PLAY button.

- If a blank interval shorter than 4 seconds is desired, press the PLAY button at the desired point during Rec mute mode. Recording will be resumed from that point.

REC RETURN operation - To return to the point at which the recording started

During recording:

When the ▷ indicator is lit:

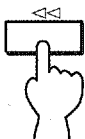

When the ◁ indicator is lit:

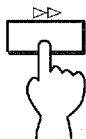

- If the PLAY button is pressed during recording, Rec return operation automatically rewinds the tape to the point where the PLAY button was pressed. Only for KX-W382, when the tape counter is reset to "0000" during recording, Rec return operation automatically rewinds the tape to the "0000" point. The tape then stops in both cases.

DOLBY HX PRO DYNAMIC BIAS SERVO SYSTEM (KX-W382 only)

This unit incorporates the Dolby HX Pro system which automatically controls the effective bias to reduce distortion and noise, improving high frequency response during recording. Tapes recorded with this system retain the same high quality even when played back on any other cassette deck.

Dolby noise reduction and HX Pro headroom extension manufactured under license from Dolby Laboratories Licensing Corporation, HX Pro originated by Bang & Olufsen.

"DOLBY", the double-D symbol  and "HX PRO" are trademarks of Dolby Laboratories Licensing Corporation.

DUBBING (From DECK B to DECK A)

Open the cassette compartments by pressing the EJECT buttons and load a blank cassette tape in DECK A and the original cassette tape in DECK B.

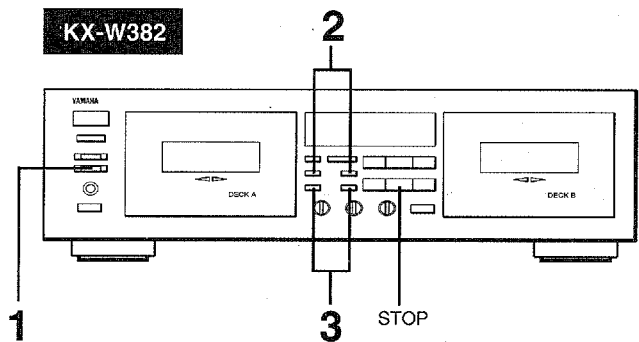

Display during dubbing

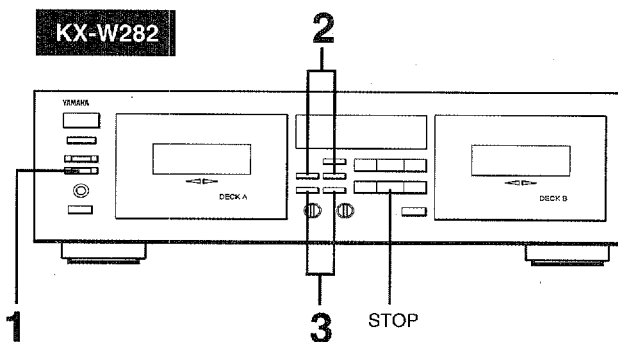
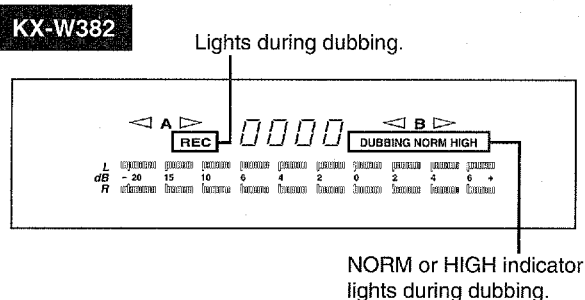

Display during dubbing

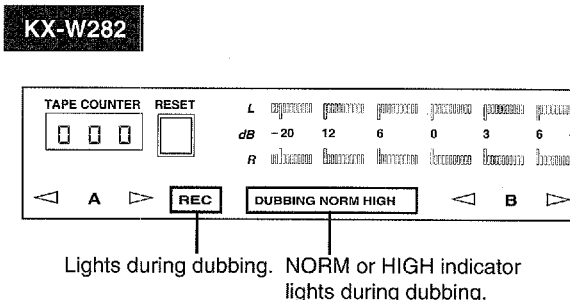

1 Set the REVERSE MODE selector as desired.

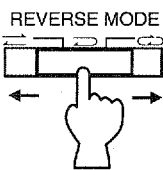

2 Set the DIRECTION buttons for DECKs A and B.

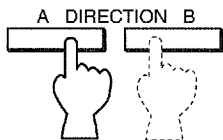

3 Set the DUBBING speed to either NORM (normal speed) or HIGH (2 times normal speed) with the DUBBING buttons*. Dubbing starts automatically.

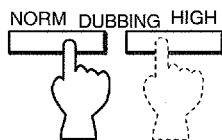

The corresponding NORM or HIGH indicator lights on the display.

* Higher quality sound will be obtained with the NORM setting.

To stop dubbing

Press the STOP button. (When DECK A is selected with the DECK A/B button, both decks stop simultaneously and the dubbing mode is canceled. When DECK B is selected, DECK B stops immediately and then DECK A stops after recording a 4-second blank section.)
When the tape in DECK A reaches its end, DECK A and DECK B stop at the same time.
When the tape in DECK B reaches its end, DECK B stops and DECK A stops after providing a blank section of about 4 seconds.

Available operations while dubbing

The Rec Return function can be carried out on DECK A. Refer to "REC RETURN operation" on the previous page. While dubbing, the buttons other than << and >> buttons cannot be operated.

Note

During dubbing, the Dolby NR is automatically set to OFF and the recorded tape can be dubbed as it is. (When the tape to be dubbed is recorded with Dolby NR, the Dolby NR effect is also dubbed.)

Synchronized recording function

When operating this unit in combination with the YAMAHA CD Player which has SYNCHRO button on its remote control transmitter, CD Synchronized recording function can be utilized. This function is operated with the remote control transmitter of the CD Player. (Regarding the operation, refer to the manual of the CD Player.)

The SYNCHRO indicator of KX-382 or REC indicator of KX-W282 lights when the SYNCHRO button of the remote controller is pressed.

CASSETTE TAPES

CASSETTE TAPES

There are many different types of cassette tapes available. However, they all conform to standard specifications so any brand may be used with the deck.

- Classification of Cassette Tapes by Formulation:
Cassette tapes are available in four basic types depending on their formulation, or type of magnetic material and manufacturing process. These four types are commonly known as Normal (Type I/NORM), Chrome (Type II/HIGH $\langle\text{CrO}_2\rangle$), Ferrichrome (Type III/FeCr), and Metal (Type IV/METAL), and they each require specific tape deck adjustments for optimum performance.

* YAMAHA does not recommend the use of 120 minute length cassettes since the extreme thinness of the tape makes them susceptible to mechanical and recording problems.

AUTO TAPE SELECTOR DETECTION SLOTS

The deck has a built-in Auto Tape Selector which automatically adjusts for the proper bias, level and equalization according to the tape formulation — all you have to do is to load a cassette and the Auto Tape Selector does the rest.

The Auto Tape Selector determines which type of tape is loaded by sensing detector slots in the top of the tape shell. Each tape formulation has its own characteristic hole markings standardized by the tape industry.

- Early model Metal (Type IV/Metal) tape formulation cassette shells do not have the slots for Auto Tape Selector operation. As a result, early model Metal type tapes recorded on another deck will be played back with the deck at the Chrome (Type II/HIGH $\langle\text{CrO}_2\rangle$) settings. YAMAHA does not recommend using this kind of tape.
- The deck does not have the required setting for Ferrichrome (Type III/FeCr) tape, since this tape formulation is not widely used. Should you use a Ferrichrome tape, it will be recorded and played back at the Normal (Type I/NORM) settings, which will result in an unnatural high frequency emphasis. This effect may be compensated for somewhat by adjusting the PLAY TRIM control and/or the tone controls of your amplifier/receiver during playback.

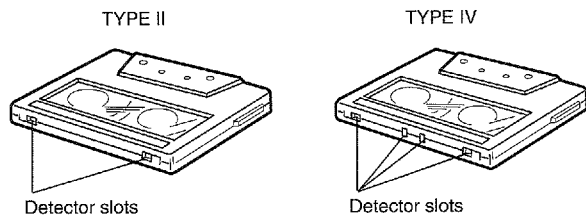

PROTECTING YOUR RECORDINGS

All cassette tapes are provided with erasure protection holes to prevent accidental erasure of recorded contents. There is a small tab covering the hole on each side of the cassette, and it should be broken off after recording the tape. Without this tab covering the hole, it is impossible to record onto that tape. Thus, you can safely protect a recording for as long as you wish without fear of accidental erasure. Should you wish to use a cassette tape protected in this way for recording, simply covering the hole with adhesive tape will permit erasure and re-recording.

- When using Chrome (Type II/HIGH $\langle\text{CrO}_2\rangle$) or Metal (Type IV/METAL) tapes, make sure you do not cover the hole intended for the Auto Tape Selector operation.

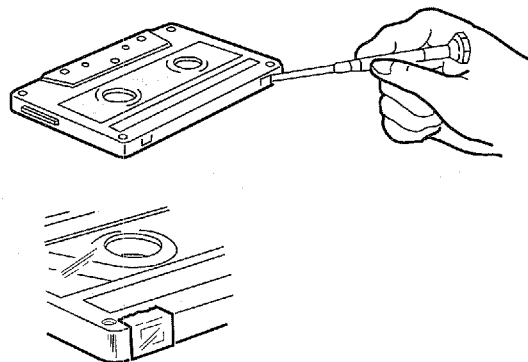

TAKING UP SLACK IN THE TAPE

As a precaution against tape entanglement and damage, remove any slack in the tape before inserting cassettes into the deck. This is accomplished by inserting a pencil, pen or similar object into one of the spools and gently winding it until all the slack is removed. You do not have to wind it too tightly.

Be careful not to touch the tape part itself. It is very delicate and touching it may damage the tape and its recorded contents.

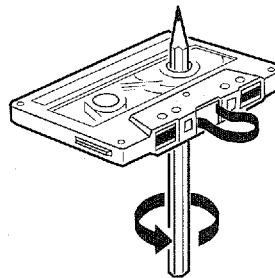

STORING CASSETTES

After putting a cassette tape back into its case, store it in a location away from exposure to direct sunlight, humidity, high temperatures, and magnetic fields (away from television sets, speakers, etc.). High temperatures and humidity will damage the tape itself, while exposure to magnetic fields may cause a loss of recorded material. Avoid touching the tape surface with your fingers, since dirt or finger oil will contaminate the deck's heads.

MAINTENANCE

CLEANING OF THE TAPE PATH

Continued high quality performance of your deck is dependent upon periodic cleaning of the heads, capstan, pinch roller, and all surfaces over which the tape travels. Normal use will cause an accumulation of dirt and dust on the heads, capstans, and pinch rollers. This can lead to poor sound quality, drop outs (intervals with no sound), unsteady tape speed, loss of high frequency response, etc. Thus, clean the heads and all surfaces over which the tape travels with a commercially available cleaning cassette and fluid type cleaner.

Inside of the cassette compartment

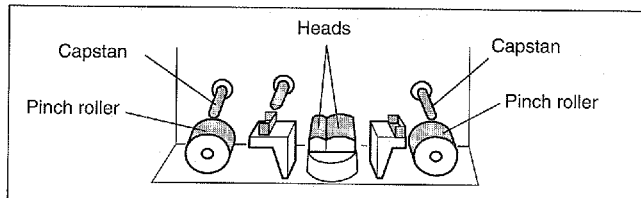

DEMAGNETIZATION

After 20-30 hours of use, enough residual magnetism will build up on the heads to cause poor high frequency reproduction. At this time you should use a commercially available cassette tape-type head demagnetizer.

- When cleaning the tape path or demagnetizing the heads, be sure to follow carefully the instructions of the concerning materials such as cleaning fluid or head demagnetizer.

OPTIONAL REMOTE CONTROL TRANSMITTER

With the optional remote control transmitter RS-KX1, you can operate this unit at your listening position. For details, refer to the instruction manual supplied with the remote control transmitter.

REMOTE CONTROL OPERATION RANGE

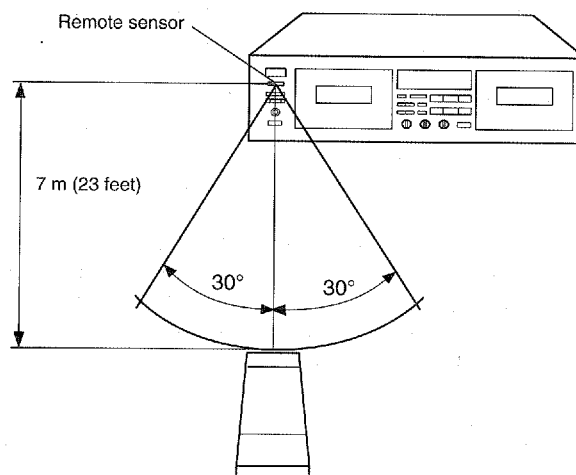
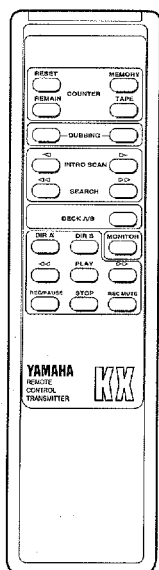

TROUBLESHOOTING

If your cassette deck fails to operate normally, check the following table. It lists common operating errors and simple measures which you can take to correct the problem. If it cannot be corrected, or the symptom is not listed, disconnect the deck's power cord and contact your local YAMAHA dealer or authorized service center for help.

Fault	Cause	Cure
Tape doesn't move in recording or playback.	<ul style="list-style-type: none"> ● Power plug is not properly plugged in. ● Cassette shell is warped or damaged. 	<ul style="list-style-type: none"> ● Reinsert plug properly. ● Do not play damaged tapes.
REC/PAUSE button fails to function.	<ul style="list-style-type: none"> ● No cassette tape loaded. ● Protective tabs are broken off. 	<ul style="list-style-type: none"> ● Load a cassette tape. ● Change tape or cover protective hole with adhesive tape.
Sounds become faint and sometimes inaudible.	<ul style="list-style-type: none"> ● Head is dirty. ● Head is magnetized. ● Tape is damaged or of poor quality. 	<ul style="list-style-type: none"> ● Clean head. ● Demagnetize head using head demagnetizer. ● Change to a different tape.
Recorded sound is distorted.	<ul style="list-style-type: none"> ● Tape is bad (stretched or deformed, etc.). ● Cassette shell is warped. ● Recording level is too high. 	<ul style="list-style-type: none"> ● Replace with a fresh tape. ● A warped cassette shell cannot be fixed. Replace with another tape and test. ● Check input level with signal level meter and use lower rec level when recording.
Tape is playing back, but no sound is heard.	<ul style="list-style-type: none"> ● Faulty connection between deck and stereo amplifier/receiver. 	<ul style="list-style-type: none"> ● Check and secure connections.
Excessive noise.	<ul style="list-style-type: none"> ● Head is dirty. ● Head is magnetized. ● Worn out or poor quality tape. ● Connection(s) improperly made. ● Affected by external electrical noise. 	<ul style="list-style-type: none"> ● Clean head. ● Demagnetize head with head demagnetizer. ● Change to better tape. ● Check input and output connections and reinsert properly. ● Move deck away from electrical appliances (TV, fluorescent light, electric blanket, etc.).
Excessive wow (wavering of the sound).	<ul style="list-style-type: none"> ● Dirty capstan, pinch roller, etc., or poor tape. ● Tape is wound unevenly. 	<ul style="list-style-type: none"> ● Clean capstan and pinch roller, or change to better tape. ● Rewind tape.
Tape stops in the middle of recording or playback.	<ul style="list-style-type: none"> ● Slack tape, or tape spillage wound around capstan. 	<ul style="list-style-type: none"> ● Insert pencil in hole in cassette shell and turn to take up slack.
Fails to record.	<ul style="list-style-type: none"> ● REC LEVEL control is set to too low. ● Protective tabs are broken off. 	<ul style="list-style-type: none"> ● Adjust REC LEVEL control. For KX-W282, adjust the L/R REC LEVEL controls. ● Change tape or cover protective hole with adhesive tape.
Search does not operate correctly.	<ul style="list-style-type: none"> ● Blank section is too short. ● Recorded section has low-level portions. ● Conversation, etc. has been recorded. 	<ul style="list-style-type: none"> ● Blank sections must be at least 4 seconds long. ● No remedy ● No remedy
High frequencies in the playback sound are emphasized and unpleasant to listen to, and noise level (hiss) is also high.	<ul style="list-style-type: none"> ● Dolby NR-recorded tape is played back in OFF position. 	<ul style="list-style-type: none"> ● Play back in appropriate Dolby NR position.
Playback sound is muffled and high frequencies are inaudible.	<ul style="list-style-type: none"> ● Normally-recorded tape is played back in Dolby NR. ● Heads are dirty. ● Heads are magnetized. 	<ul style="list-style-type: none"> ● Play back in OFF position. ● Clean heads and carry out demagnetization with head demagnetizer.
When playing back tapes recorded on other decks, meter deflections are greater (smaller) than when recorded.	<ul style="list-style-type: none"> ● Basic levels are different for different cassette decks. 	<ul style="list-style-type: none"> ● This is not a fault.
The remote control transmitter cannot be operated.	<ul style="list-style-type: none"> ● The batteries are exhausted. ● The remote control transmitter is operated from an incorrect distance or angle. ● The remote control sensor is lighted strongly. 	<ul style="list-style-type: none"> ● Replace batteries. ● Operate it from less than 7 meters (about 23 ft.) and 30°. ● Place the unit away from the strong light.

SPECIFICATIONS

Type	Auto reverse 4-track, 2-channel recording and playback stereo double cassette deck
Motors	DC servo motor x 2 (main)
Heads	Recording/playback: Hard Permalloy x 1 Playback: Hard Permalloy x 1 Erase: Double-gap Ferrite x 1
Rapid Transport	100 sec. (C-60)
Wow and Flutter	
WRMS	0.08%
W.Peak	±0.15%
Signal-to-Noise Ratio	
(Dolby NR off)	58 dB
(Dolby B NR on)	66 dB
(Dolby C NR on)	74 dB
Frequency Response (-20 dB)	
<KX-W382>	
Type I/Normal	20 ~ 17,000 Hz ±3 dB
Type II/High (CrO ₂)	20 ~ 18,000 Hz ±3 dB
Type IV/Metal	20 ~ 20,000 Hz ±3 dB
<KX-W282>	
Type I/Normal	20 ~ 16,000 Hz ±3 dB
Type II/High (CrO ₂)	20 ~ 17,000 Hz ±3 dB
Type IV/Metal	20 ~ 19,000 Hz ±3 dB
Harmonic Distortion	0.8% (KX-W382)/ 1.0% (KX-W282)
Input Sensitivity/Impedance	
Line	100 mV/43 k-ohms (KX-W382) 100 mV/35 k-ohms (KX-W282)
Output Level	
Line	570 mV/1.8 k-ohms
Phones	0.23 mW/8 ohms
Channel Separation (1 kHz)	more than 40 dB
Crosstalk (125 Hz)	more than 55 dB

GENERAL

Power Supply	
U.S.A. and Canada model	120 V, 60 Hz
Europe model	230 V, 50 Hz
U.K. model and Australia model	240 V, 50 Hz
General model	110/120/220/240 V, 50/60 Hz
Power Consumption	15 W (KX-W382) 12 W (KX-W282)
Dimensions (W x H x D)	435 x 126 x 280 mm (17-1/8" x 4-15/16" x 11")
Weight	4.8 kg (10 lbs. 9 oz.)(KX-W382) 4.7 kg (10 lbs. 6 oz.)(KX-W282)
Accessory	
Audio cord	1 pair

* Specifications subject to change without notice.

YAMAHA

YAMAHA ELECTRONICS CORPORATION, USA 6660 ORANGETHORPE AVE., BUENA PARK, CALIF. 90620, U.S.A.
YAMAHA CANADA MUSIC LTD. 135 MILNER AVE., SCARBOROUGH, ONTARIO M1S 3R1, CANADA
YAMAHA ELECTRONIK EUROPA G.m.b.H. SIEMENSSTR. 22-34, D-2084 RELINGEN, BEI HAMBURG, F.R. OF GERMANY
YAMAHA ELECTRONIQUE FRANCE S.A. 17 RUE DES CAMPANULES, LOGNES 77321 MARNE LA VALLEE CEDEX 2 FRANCE
YAMAHA ELECTRONICS (UK) LTD. YAMAHA HOUSE, 200 RICKMANSWORTH ROAD WATFORD, HERTS WD1 7JS, ENGLAND
YAMAHA SCANDINAVIA A.B. J A WETTERGRENS GATA 1, BOX 30053, 400 43 VASTRA FRÖLUNDA, SWEDEN
YAMAHA MUSIC AUSTRALIA PTY, LTD. 17-33 MARKET ST., SOUTH MELBOURNE, 3205 VIC., AUSTRALIA

YAMAHA CORPORATION
VR 30310