

Front Surround System

MusicCast BAR 400



YAS-408



Contents

Before using the unit	3
------------------------------------	----------

Features.....	3
---------------	---

PREPARATION

Supplied items	4
-----------------------------	----------

Part names and functions	6
---------------------------------------	----------

Installation	9
---------------------------	----------

Connections	10
--------------------------	-----------

PLAYBACK

Operations.....	13
------------------------	-----------

NETWORKS

Connecting to a network.....	18
-------------------------------------	-----------

Specifications	22
-----------------------------	-----------

About this Quick Start Guide

This Quick Start Guide provides basic setup to use the unit and feature of the unit. The unit is equipped with a number of other functions not described in this document. For more information about this product, refer to the Owner's Manual on the Yamaha website.

Follow one of the methods described below to view the latest Owner's Manual.

In HTML format



- Scan the QR code found on the front cover of this document.
- Visit the following website.
<https://manual.yamaha.com/av/18/yas408/>

In PDF format

- Visit the following website.
<https://download.yamaha.com/>

[For U.S. customers only]

Visit the following website for additional information, FAQ's, downloads such as "Owner's Manual" and product updates.
<http://usa.yamaha.com/support/>

- In this booklet, iOS and Android mobile devices are collectively referred to as "mobile devices". The specific type of mobile device is noted in explanations as needed.
- Trademarks and trade names used in this document are those of their respective owners. See the Owner's Manual for more information.
- This manual uses the following signal words for the important information:
 -  **WARNING**
This content indicates "risk of serious injury or death."
 -  **CAUTION**
This content indicates "risk of injury."
 - **NOTICE**
Indicates points that you must observe in order to prevent product failure, damage or malfunction and data loss, as well as to protect the environment.
 - **NOTE**
Indicates notes on instructions, restrictions on functions, and additional information that may be helpful.

Before using the unit

Features

Introduction

This front surround system allows for the enjoyment of dynamic sound with video played on a TV.

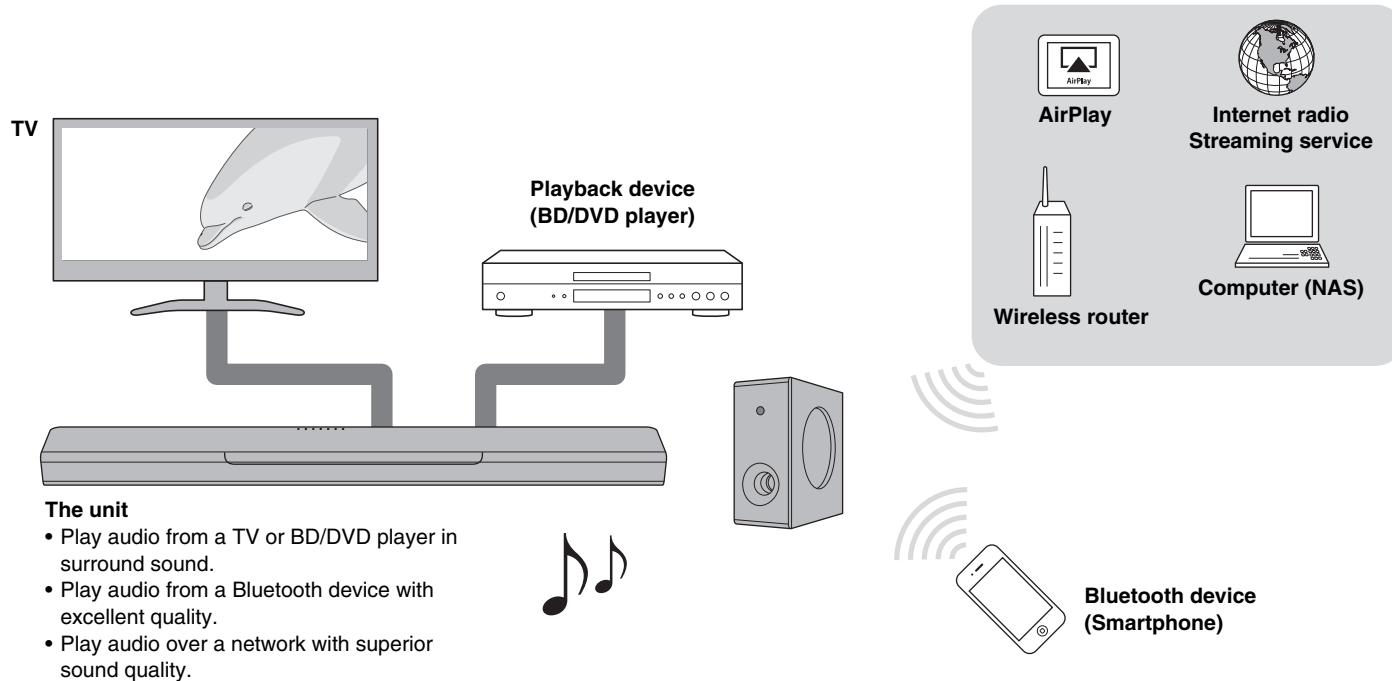

Supplied items

Make sure you have received all of the following items.



Center unit (YAS-CU408)



Remote control

A CR2025 Lithium battery has already been inserted into the remote control.

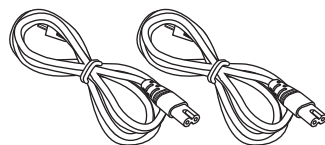

Power cord × 2



Optical digital audio cable

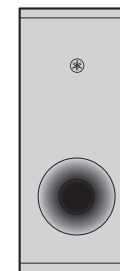

Wireless subwoofer (NS-WSW43)

In this manual, the wireless subwoofer is referred to as "subwoofer".



Mounting template

Use when mounting the center unit on a wall



Quick Start Guide (this booklet)



Safety Brochure

Preparing the remote control

Remove the battery's insulating strip before attempting to use the remote control.

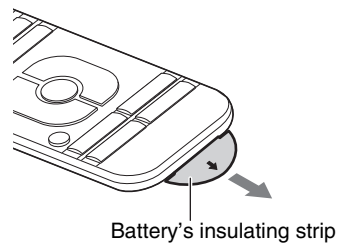

Operating range of the remote control

Operate the remote control within the range as shown below.

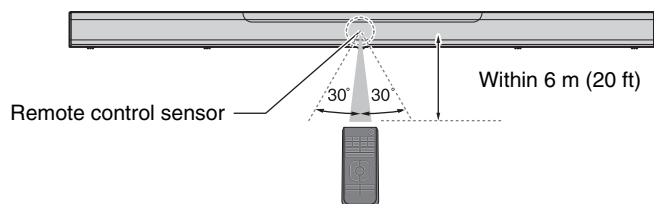

Replacing the battery in the remote control

Press and hold the release tab firmly in the direction indicated by [A], and slide the battery holder out in the direction indicated by [B].

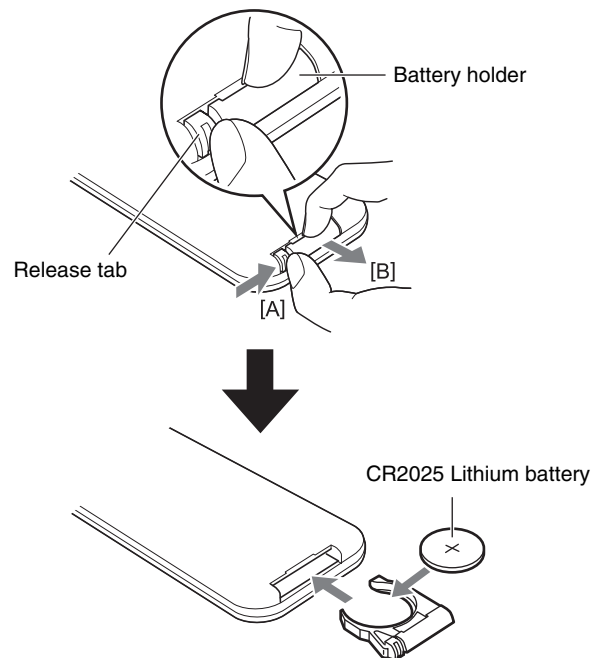

Part names and functions

Center unit (front panel/top panel)

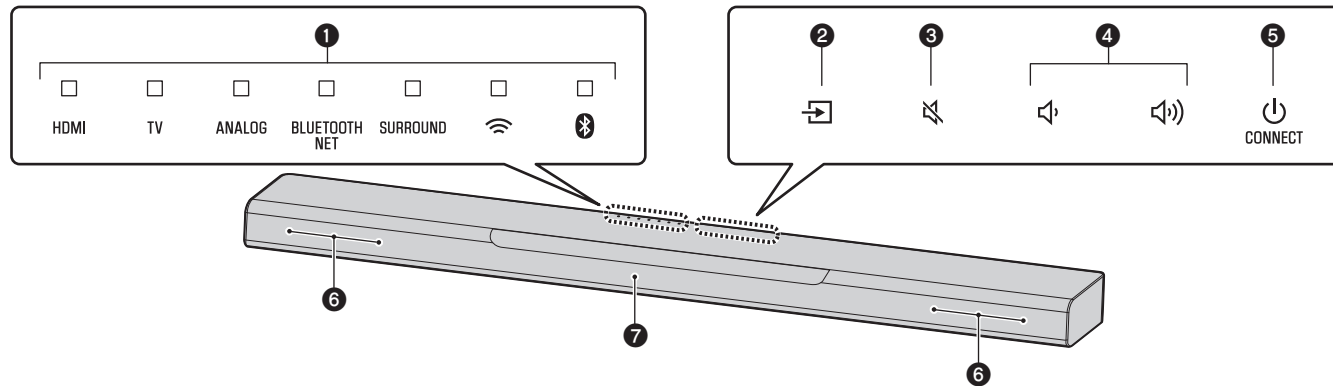

1 Indicators

The indicators on the top panel flash or glow, to show the operation and setting status. In this manual, indicators status, such as off, glowing, and flashing, are shown as the illustrations below.



NOTE

- The brightness of the indicators can be changed using DIMMER on the remote control (p.17).

2 (input)

Select an input source to be played back (p.14).

3 (mute)

Mute the audio output. Touch  again to unmute (p.15).

4 (volume +/-)

Adjust the volume (p.15).

5 (power)/CONNECT

Turn on or off the unit (p.13).

Use to connect the unit to a network using the MusicCast CONTROLLER app (p.19).

NOTE

- The unit may automatically turn off when the auto power standby function is enabled. For details, see "Setting the auto power standby function" in the Owner's Manual.

6 Speakers

7 Remote control sensors

Receive infrared signals from the remote control of the unit (p.13).

NOTE

- 2, 3, 4 and 5 are touch sensors. Touch icons with your finger to control functions.
- Do not place any objects on the touch panel as doing so may result in unintended operations.
- When touch panel control is disabled, no operations can be performed using the unit's touch panel. This prevents accidental operation of the unit. For details, see "Enabling/disabling touch panel control (child lock function)" in the Owner's Manual.

Center unit (rear panel)

The illustrations in this manual include labels next to the jacks on the bottom of the unit for easy identification.

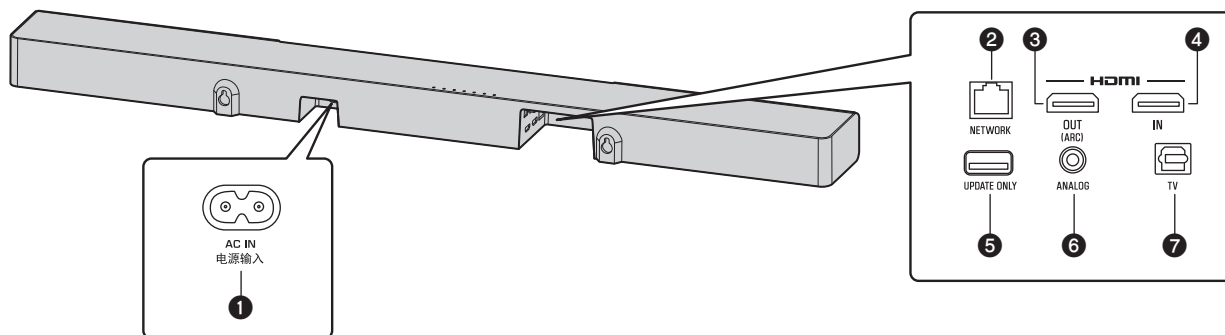

❶ AC IN jack

Connect the power cord of the center unit (p. 11).

❷ NETWORK jack

For connecting to a network with a network cable (p. 18).

❸ HDMI OUT (ARC) jack

For connecting to an HDMI-compatible TV and outputting video/audio signals (p. 10).
When a TV that supports Audio Return Channel (ARC) is used, TV audio signal can also be input through this jack.

❹ HDMI IN jack

For connecting to an HDMI-compatible playback device, such as a BD/DVD player, a satellite and cable TV tuner, and a game console, and inputting video/audio signals (p. 10).

❺ UPDATE ONLY jack

Use to update this unit's firmware.

Refer to the instructions supplied with the firmware for details.

❻ ANALOG input jack

For connecting to an external device with a 3.5 mm stereo mini plug cable and inputting audio signals (p. 11).

❼ TV input jack

For connecting to a TV with an optical digital audio cable and inputting audio signals (p. 10).

Subwoofer

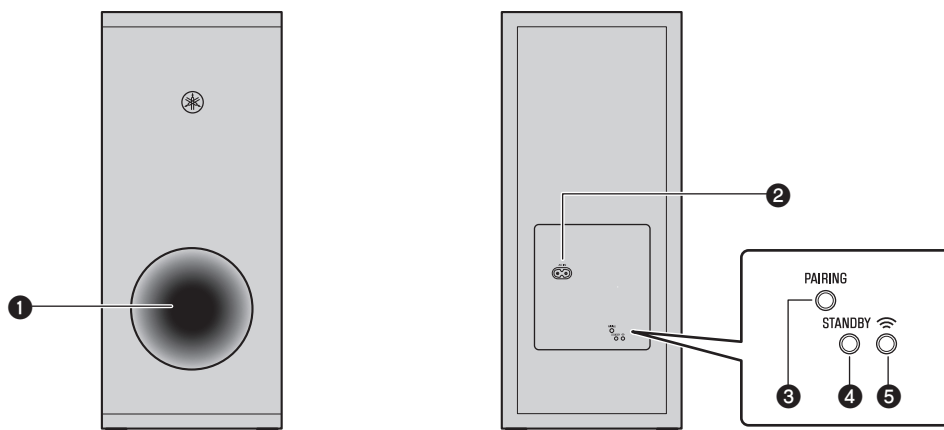

❶ Bass reflex port

❷ AC IN jack

Connect the power cord of the subwoofer (p.11).

❸ PAIRING button

Use to pair the center unit with the subwoofer manually.

❹ STANDBY indicator

Shows subwoofer's status (p.13).

❺ indicator

Glow when the center unit and subwoofer are connected wirelessly (p.12).

Installation

The center unit can be installed on a TV stand, etc.

Position the subwoofer to the left or right of the center unit. Angle the subwoofer slightly toward the center of the room to prevent sound from reflecting off of walls.

Installing the center unit on a TV stand

Position the center unit with the touch panel facing up.

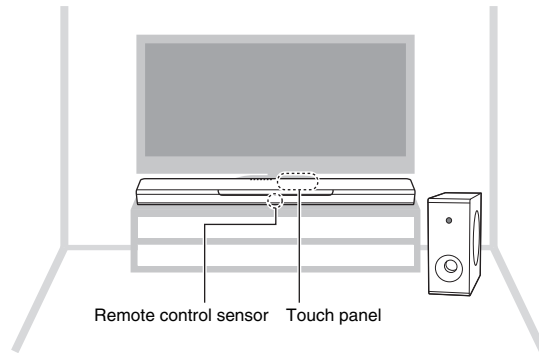

NOTICE

- Do not stack the center unit and a BD player or other device directly on each other. Doing so may cause a malfunction due to vibrations.
- Avoid touching, and never place any weight or pressure on, the subwoofer's speaker (portion covered with fabric). Doing so may damage the speakers.
- Do not install the subwoofer where the speaker (portion covered with fabric) is too close to a wall, or cover the subwoofer's bass reflex port. Doing so may reduce sound volume.
- The subwoofer can only be used in its upright position. Do not position the subwoofer on its side.
- This unit contains non-magnetic shielding speakers. Do not place magnetically sensitive items (hard disk drive, etc.) near the unit.
- The center unit and subwoofer communicate wirelessly. Do not place objects that block or interfere with wireless signals, such as metallic furniture or devices, between the center unit and the subwoofer as wireless communication may be adversely affected.

NOTE

- The center unit can also be mounted on a wall. Some knowledge of building construction is required for safe installation. Please have a qualified contractor or dealer install the center unit on a wall. For details, see "Information for qualified contractors or dealers" in the Owner's Manual.

Connections

1 Connecting a TV and set-top box

For the cable connection, follow the procedure below.

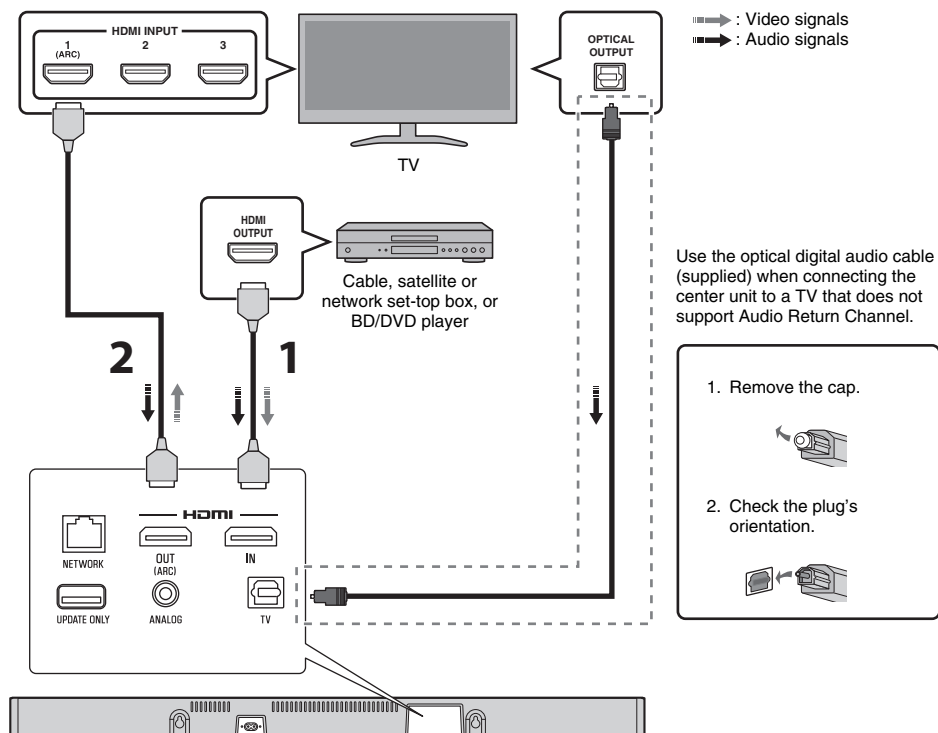

1 HDMI cable (sold separately)

The digital audio/video signals from the set-top box or BD/DVD player are input to this unit.

2 HDMI cable (sold separately)

Digital video from the set-top box or BD/DVD player is displayed on the TV.

NOTE

- Use a 19-pin HDMI cable with the HDMI logo printed on it. A cable with a maximum length of 5 m (16 ft) is recommended to prevent degradation of signal quality.
- Use of a flat HDMI cable may make installing the center unit difficult because the cable will be bent by the bottom of the center unit when connected. Confirm the layout and position of jacks on the center unit before choosing an appropriate HDMI cable.
- This unit supports HDCP version 2.2, a copy protection technology. For playback of 4K video, connect the unit to the HDMI input jack (one compatible with HDCP 2.2) on an HDCP 2.2-compliant TV, and to the HDMI output jack on a HDCP 2.2-compliant BD/DVD player.
- Use a premium high-speed HDMI cable for playback of 3D and 4K video content.

Audio Return Channel (ARC) supported TV

- Connect an HDMI cable to the audio return channel supported jack (the jack with "ARC" indicated) on TV.
- Video and audio content from playback devices can be output from the TV even when this unit is off (HDMI signal pass-through).

What is Audio Return Channel (ARC)?

In order for the unit to play audio from a TV, the TV must usually be connected to the unit via an audio cable as well as an HDMI cable. If, however, the TV supports Audio Return Channel (ARC), TV audio signals can be input to the unit via the HDMI cable that outputs video signals from the unit to the TV.

2 Connecting a game console via the analog jack

Connect an external device, such as a game console or TV that does not have an optical digital audio output, to the ANALOG input jack of the center unit.

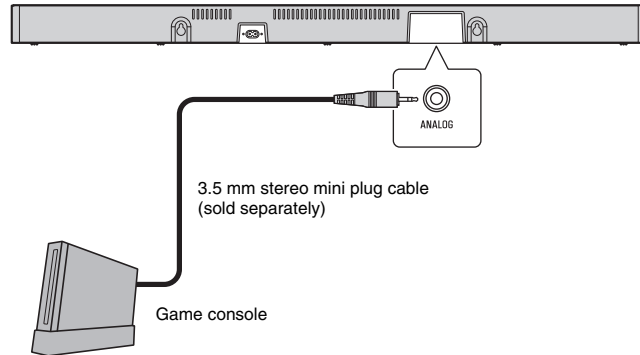

CAUTION

- If volume can be adjusted on the device connected to the unit's ANALOG input jack, set that device's volume to the same level as that of other devices connected to the unit's HDMI jacks to prevent volume from being louder than expected.

3 Connecting the power cord

Once all connections have been made, connect the supplied power cords to the AC IN jacks on the center unit and subwoofer respectively, and plug the power cords into AC wall outlets.

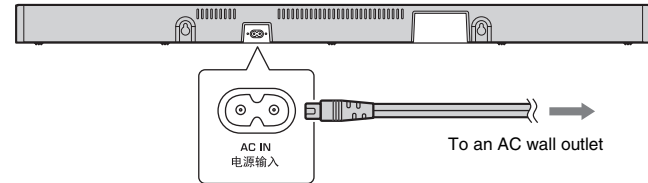

Center unit

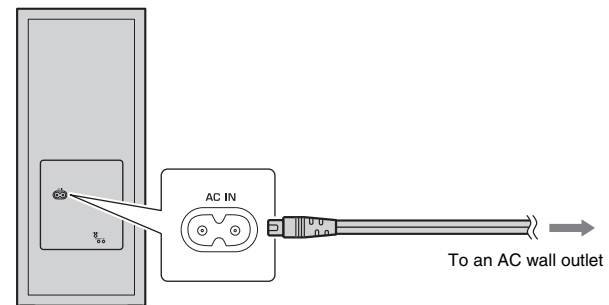

Subwoofer



4 Turning on the unit

Press  (power) on the remote control or touch /CONNECT on the center unit. The unit turns on and the center unit and subwoofer are automatically connected via wireless connection. Once the connection has been successfully established, the  indicator on the subwoofer's rear panel glows, and the unit is ready for playback.

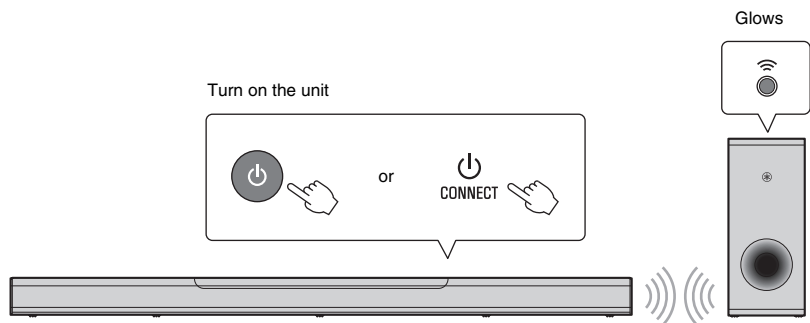

NOTE

- If the  indicator on the subwoofer does not glow properly, see "No sound is coming from the subwoofer" in the Owner's Manual.

Operations

Remote control signal transmitter

Transmits infrared signals.



1

(power) button

Turns on or off the unit.

Center unit

Turned on



The indicator for the last input source selected glows.

Indicates the surround setting, and network or Bluetooth connection status.

Turned off/network standby



Subwoofer

Turned on



Turned off/network standby



NOTE

- When the unit is turned on for the first time after purchase, the Wi-Fi indicator on the center unit flashes slowly.



While the Wi-Fi indicator is flashing, network settings from your iOS device (an iPhone, etc.) can be applied to the unit to connect the unit to a wireless network. For details on settings, see "Connecting to a network using the WAC function" in the Owner's Manual. Press any button on the remote control to cancel this function if it will not be used. The Wi-Fi indicator does not flash if the unit's NETWORK jack is connected to a router using a cable (wired connection).

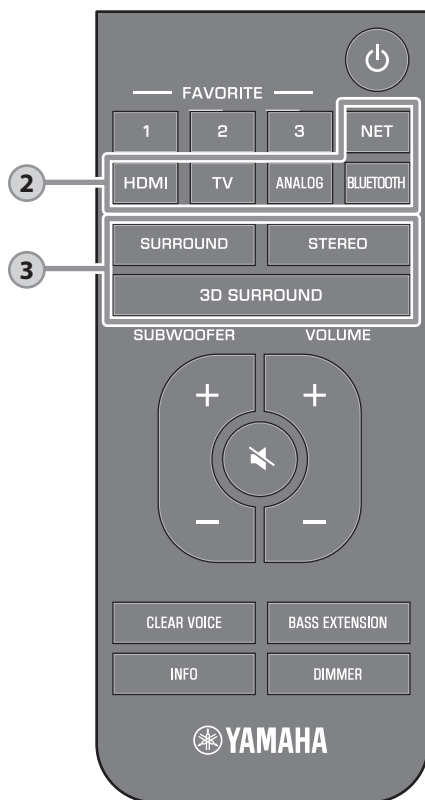

2

Input buttons

Select an input source to be played back.

TVTV audio or sound from a device connected to the unit's TV input jack

HDMI.....Sound from a device connected to the HDMI input jack

ANALOG Sound from a device connected to the ANALOG input jacks

BLUETOOTH ..Sound from a Bluetooth connected device

NET.....Audio acquired via a network

The indicator for the selected input source glows.

(Example: when TV is selected)

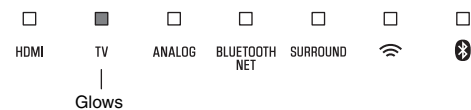

NOTE

- To play sound from the device connected to the TV or to watch video from the device, set the TV's input source to the playback device.
- For details on playing music files stored on a Bluetooth device, see "Listening to music stored on a Bluetooth® device" in the Owner's Manual.
 - "Play music with AirPlay"
 - "Play music stored on a media server (computer or NAS)"
 - "Listening to Internet radio"
 - "Listening to streaming services"
 - "Play music stored on mobile devices"
- For details on playing content via a network, see the following in the Owner's Manual:

3

3D SURROUND, SURROUND and STEREO buttons

Switch to 3D surround playback, surround playback, and stereo (2-channel) playback.

3D SURROUND button

Switch to 3D surround playback. When 3D surround is selected, DTS Virtual:X makes it possible to hear sound not only from horizontal directions, but also from varying heights.

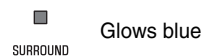

SURROUND button

Switch to surround playback.



STEREO button

Switch to stereo (2-channel) playback.



NOTE

- The TV Program, Movie, Music, Sports, or Game surround mode can be selected using the dedicated MusicCast CONTROLLER app installed on a mobile device when the unit is connected to a network and registered as a MusicCast-enabled device with the app (p. 19).

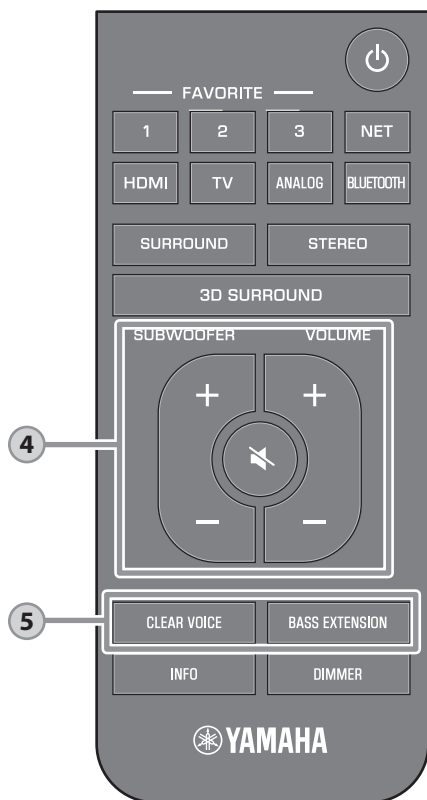

4

SUBWOOFER (+/-) buttons

Adjust the volume of the subwoofer.

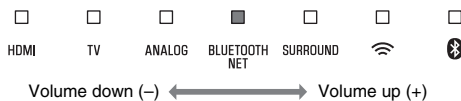

VOLUME (+/-) buttons

Adjust the volume of the unit.

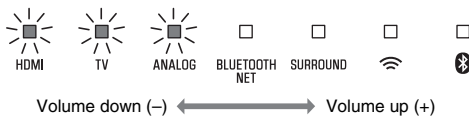

Mute (mute) button

Mute the audio output. Press the button again to unmute.

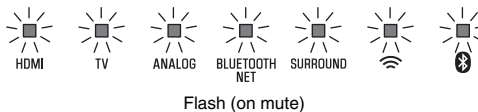

5

CLEAR VOICE button

Enable/disable the clear voice function. When this function is enabled, human voices such as lines in movies and TV shows, or news and sport commentary, are played clearly.

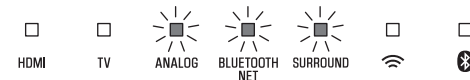

Enabled: Flash three times and turn off
Disabled: Flash once and turn off

BASS EXTENSION button

Enable/disable the bass extension function. When this function is enabled, you can enjoy a powerful bass sound.



Enabled: Flash three times and turn off
Disabled: Flash once and turn off



6

INFO button

Press INFO to confirm the type of audio signal being played, as well as settings for functions such as the bass extension function.

The indicators on the unit will show the following audio information for three seconds immediately after INFO is pressed.

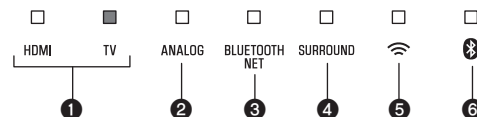

1 Show the type of audio signal.

HDMI glows (white): Dolby Digital

HDMI glows (red): DTS

TV glows (white): AAC

HDMI and TV off: PCM/analog input/no input

2 Show whether Dolby Pro Logic II is enabled or disabled. Dolby Pro Logic II is enabled automatically when 2-channel stereo signals are played in surround sound.

Glows: Enabled

Off: Disabled

3 Show the bass extension function setting.

Glows: Enabled

Off: Disabled

4 Show the clear voice function setting.

Glows: Enabled

Off: Disabled

5 Show the network standby function setting.

Glows: Enabled

Off: Disabled

6 Show the Bluetooth function setting.

Glows (blue): Enabled

Off: Disabled



7

FAVORITE (1-3) buttons

Use the FAVORITE button to register input sources played over a network (Internet radio stations, music files stored on a media server, etc.) as favorites.

Register favorites with the FAVORITE buttons

- 1 Play the input source to be registered.
- 2 Press and hold FAVORITE 1, 2, or 3 at least three seconds.

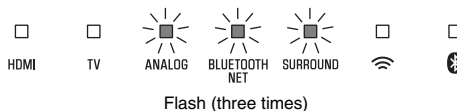

Play favorite input sources

- 1 Press FAVORITE 1, 2, or 3 to which the input source has been assigned.

NOTE

- Favorites assigned to FAVORITE 1, 2, or 3 using the remote control will also be assigned to MusicCast CONTROLLER app "Favorites" 1, 2, and 3. If favorite 1, 2, or 3 is changed with either the unit or the MusicCast CONTROLLER app, the corresponding favorite will also be automatically changed with the other.

8

DIMMER button

Change the brightness of the indicators. Each time DIMMER is pressed, the brightness of the indicators changes as follows.

Dim (default setting) → Off → Bright



Indicators glow brightly just after operation and change to the specified brightness after a few seconds.

Connecting to a network

Network functions and the MusicCast CONTROLLER app

A network connection allows you to listen to Internet radio stations or music streaming services, and to use AirPlay to play music files, or to play music files stored on your computer (media server) via this unit.

Most playback requires the “MusicCast CONTROLLER” app for mobile devices. Install and use the MusicCast CONTROLLER app on your mobile device to play music files.

Proceed from network connection to playback in the following sequence.

1 Choose a wired network connection (p. 18) or a wireless network connection (p. 19).



2 Use the MusicCast CONTROLLER app to connect the unit to a network, and register the unit as a MusicCast-enabled device (p. 19).



3 Use the MusicCast CONTROLLER app* to play music over a network.
For details on playing music over a network, refer to the Owner’s Manual.

* AirPlay can be used to play music files without using the MusicCast CONTROLLER app.

NOTE

- To use network function, the unit, your computer and mobile device must be connected to the same router.
- When using a multiple SSID router, access to the unit might be restricted depending on the SSID to connect. Connect the unit and mobile device to the same SSID.
- Some security software installed on your computer, or network device settings (such as a firewall), may block the unit’s access to your computer or Internet radio stations. Should this occur, change security software and/or network device settings.
- A network connection cannot be established if the MAC address filter on your router is enabled. Check your router’s settings.
- To configure your router’s subnet mask manually, apply the same subnet used by this unit to all devices.
- Use of a broadband connection is recommended when using Internet services.
- The unit cannot be connected to a network that requires manual setup. Connect the unit to a DHCP-enabled router.

Wired network connections

To use a wired network connection, connect the unit to a router via an STP network cable (category 5 or higher straight cable; sold separately).

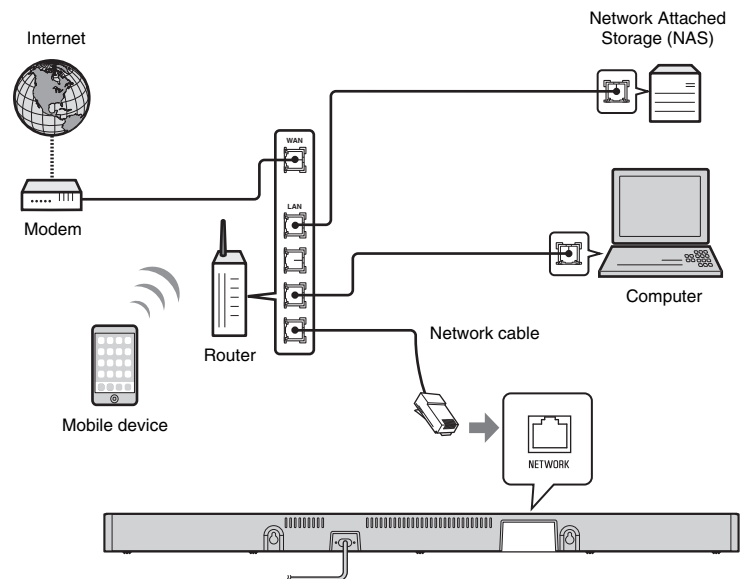



NOTE

- If network connections or settings are changed, use the MusicCast CONTROLLER app to connect the unit to a network and register the unit as a MusicCast-enabled device again (p. 19).

Wireless network connections

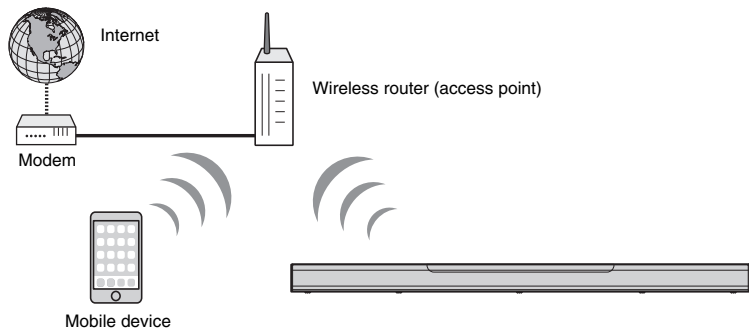
Connect the unit to a wireless router (access point) to use a network.



The  indicator on the unit glows when the unit is connected to a wireless network.

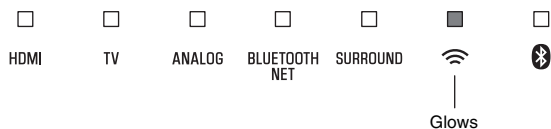

NOTE

- If the unit and the wireless router (access point) are too far apart, the unit may not connect to a wireless router (access point). In such case, place them close to each other.

Connecting with the MusicCast CONTROLLER app (registering the unit as a MusicCast-enabled device)

Install the MusicCast CONTROLLER app on your mobile device to connect the unit to a network and register it as a MusicCast-enabled device.

NOTE

- Confirm that your mobile device is connected to your home router before beginning.
- This section uses MusicCast CONTROLLER app screens displayed in English on an iPhone as examples.
- MusicCast CONTROLLER app screens and menu labels are subject to change without prior notice.

1 Install the MusicCast CONTROLLER app on your mobile device, and open the app.

Search for “MusicCast CONTROLLER” on the App Store or Google Play.

2 Tap “Setup”.



3 Turn on the unit, and then tap “Next”.

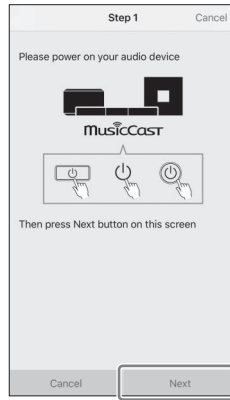

4 Touch and hold /CONNECT until the indicator on the unit starts flashing.

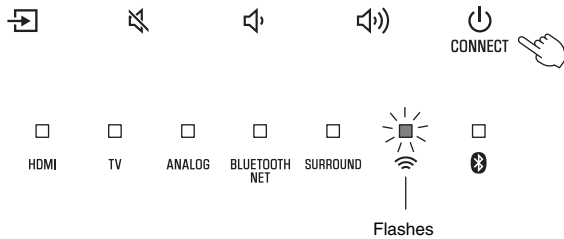

5 Follow the on-screen instructions to configure network settings.

NOTE

- When a screen like that below is displayed, follow the on-screen instructions to configure network settings.

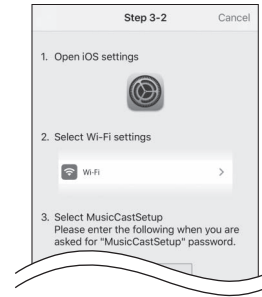

1. Use the Home button on your mobile device to return to the Home screen.
2. Select “Wi-Fi” from “Settings”.
3. Select “MusicCastSetup” from “CHOOSE A NETWORK...”. If the on-screen instructions prompt you to enter the MusicCastSetup password, enter the password displayed on the screen.
4. Use the Home button to return to the MusicCast CONTROLLER app.

- When a screen like that at left below is displayed, select the network to which the unit will be connected and enter the router’s password (encryption key). The router’s password (encryption key) is often noted on the router itself. Refer to documentation supplied with the router for details.

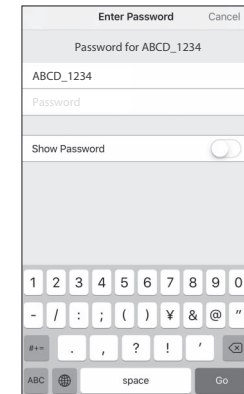

6 To register the unit as a MusicCast-enabled device, configure the following items.

- Location name (“home”, “John’s house”, etc.)
- Name and photo of the room where the unit is installed

The location name, and the name and photo of the room where the unit is installed can be changed later.

Location Name Cancel

Enter Location Name

Home1

Location name is used to recognize a MusicCast location which contains one or several rooms (Ex. My place, workplace, etc.)
This can be changed later

Next

Network connection with the MusicCast CONTROLLER app is now complete, and the unit has been registered as a MusicCast-enabled device.

NOTE

- If a different MusicCast-enabled device is already registered with the MusicCast CONTROLLER app, tap  (Settings) in the room selection screen, and then select “Add New Device” to add the unit to the app.

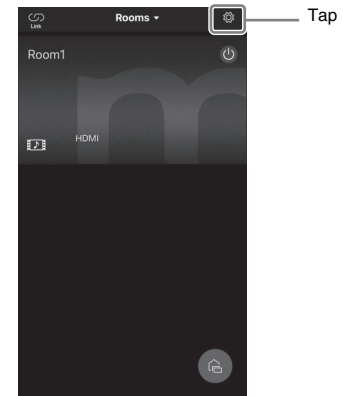

Specifications

Specifications (YAS-CU408)

Amplifier section		
Maximum rated output power	Front L/R	50 W × 2ch

Speaker section		
Front L/R	Type	Acoustic suspension type (non-magnetic shielding)
	Driver	4.6 cm (1-3/4") cone × 4
	Frequency response	160 Hz to 9 kHz
	Impedance	4 Ω (8 Ω × 2)
Tweeter	Driver	2.5 cm (1") dome × 2
	Frequency response	9 kHz to 23 kHz
	Impedance	4 Ω

Decoder	
Supported audio signal (HDMI/optical input)	PCM (up to 5.1ch) Dolby Digital (up to 5.1ch) DTS Digital Surround (up to 5.1ch)

Input jacks	
HDMI	1 (HDMI IN)
Digital (Optical)	1 (TV)
Analog (3.5 mm stereo mini)	1 (ANALOG)

Output jacks	
HDMI	1 (HDMI OUT (ARC))

Other jacks	
USB	1 (UPDATE ONLY)
LAN	1 (NETWORK)

Bluetooth		
Bluetooth version	Ver 4.2	
Supported profiles	A2DP, AVRCP	
Supported codecs	Sink: SBC, AAC	
Bluetooth class	Bluetooth Class 2	
Range (line-of-sight)	Approx. 10 m (33 ft)	
Supported content protection method	SCMS-T (sink)	
Radio frequency	U.K. and Europe models	2402 MHz to 2480 MHz
Maximum output power (EIRP)	U.K. and Europe models	6.5 dBm (4.5 mW)

Network	
Ethernet standard	100BASE-TX/10BASE-T
Supported codecs	WAV (PCM format only) /AIFF/FLAC: up to 192 kHz ALAC: up to 96 kHz MP3/WMA/MPEG-4 AAC: up to 48 kHz
PC client function AirPlay supported Internet radio	

Wi-Fi			
Wireless LAN standards	IEEE 802.11 a/b/g/n/ac* * 20 MHz channel bandwidth only		
Radio frequency band	2.4 GHz/5 GHz		
Available security method	WEP, WPA2-PSK (AES), Mixed Mode		
Radio frequency	U.K. and Europe models	2.4 GHz band	2402 MHz to 2482 MHz (20 MHz)
		5 GHz band	5170 MHz to 5250 MHz (20 MHz) 5250 MHz to 5330 MHz (20 MHz) 5490 MHz to 5710 MHz (20 MHz) 5735 MHz to 5835 MHz (20 MHz)
Maximum output power (EIRP)	U.K. and Europe models	2.4 GHz band	19.2 dBm (83.2 mW)
		5 GHz band	5170 MHz to 5250 MHz (20 MHz): 21.5 dBm (141.3 mW) 5250 MHz to 5330 MHz (20 MHz): 21.8 dBm (151.4 mW) 5490 MHz to 5710 MHz (20 MHz): 24.1 dBm (257.0 mW) 5735 MHz to 5835 MHz (20 MHz): 13.5 dBm (22.4 mW)

General			
Power supply	U.S.A. and Canada models	AC 120 V, 60 Hz	
	Australia model	AC 240 V, 50 Hz	
	Europe, Asia, and Russia models	AC 110 to 240 V, 50/60 Hz	
	U.K. model	AC 230 V, 50 Hz	
	Taiwan model	AC 110 V, 60 Hz	
	China model	AC 220 V, 50 Hz	
	Korea model	AC 220 V, 60 Hz	
Power consumption	30 W		
Standby power consumption	U.S.A., Canada and Taiwan models	HDMI control off, network standby off	0.4 W
		HDMI control off, network standby on (Wired/Wi-Fi/Bluetooth)	1.6/1.8/1.7 W
		HDMI control on, network standby off	0.7 W
		HDMI control on, network standby on	2.2 W
	U.K. and Europe models and other models	HDMI control off, network standby off	0.4 W
		HDMI control off, network standby on (Wired/Wi-Fi/Bluetooth)	1.6/1.8/1.7 W
		HDMI control on, network standby off	0.7 W
		HDMI control on, network standby on	2.2 W
Dimensions (W x H x D)	980 × 60 × 110.5 mm (38-5/8" × 2-3/8" × 4-3/8")		
Weight	2.7 kg (6 lbs)		

Specifications (NS-WSW43)

The specifications of the subwoofer are as follows.

Amplifier section	
Maximum rated output power	100 W

Speaker section		
Type	Bass reflex type (non-magnetic shielding type)	
Driver	16 cm (6-1/2") cone × 1	
Frequency response	40 Hz to 160 Hz	
Impedance	2 Ω	
Radio frequency band	2.4 GHz	
Radio frequency	U.K. and Europe models	2405.35 MHz to 2477.35 MHz
Maximum output power (EIRP)	U.K. and Europe models	9.0 dBm (8 mW)
Transmission range	10 m ([33 ft] without interference)	

General		
Power supply	U.S.A. and Canada models	AC 120 V, 60 Hz
	Europe, Asia, and Russia models	AC 110 to 240 V, 50/60 Hz
	U.K. model	AC 230 V, 50 Hz
	Taiwan model	AC 110 V, 60 Hz
	Korea model	AC 220 V, 60 Hz
	China model	AC 220 V, 50 Hz
	Australia model	AC 240 V, 50 Hz
Power consumption	19 W	
Standby power consumption	U.S.A., Canada and Taiwan models	0.8 W
	U.K. and Europe models and other models	0.8 W
Dimensions (W x H x D)	180 × 417 × 405 mm (7-1/8" × 16-3/8" × 16")	
Weight	9.4 kg (21 lbs)	

NOTE

- The contents of this manual apply to the latest specifications as of the publishing date. To obtain the latest manual, access the Yamaha website then download the manual file.

YAMAHA CORPORATION

10-1 Nakazawa-cho, Naka-ku, Hamamatsu, 430-8650 Japan

Yamaha Global Site
<https://www.yamaha.com/>

Yamaha Downloads
<https://download.yamaha.com/>

Manual Development Group
© 2018 Yamaha Corporation

Published 03/2020 KSOD-B0

AV17-0268